

Schlüter® - BEKOTEC-THERM

Illustrated price list BT 25

Ireland · Effective 1st January 2025

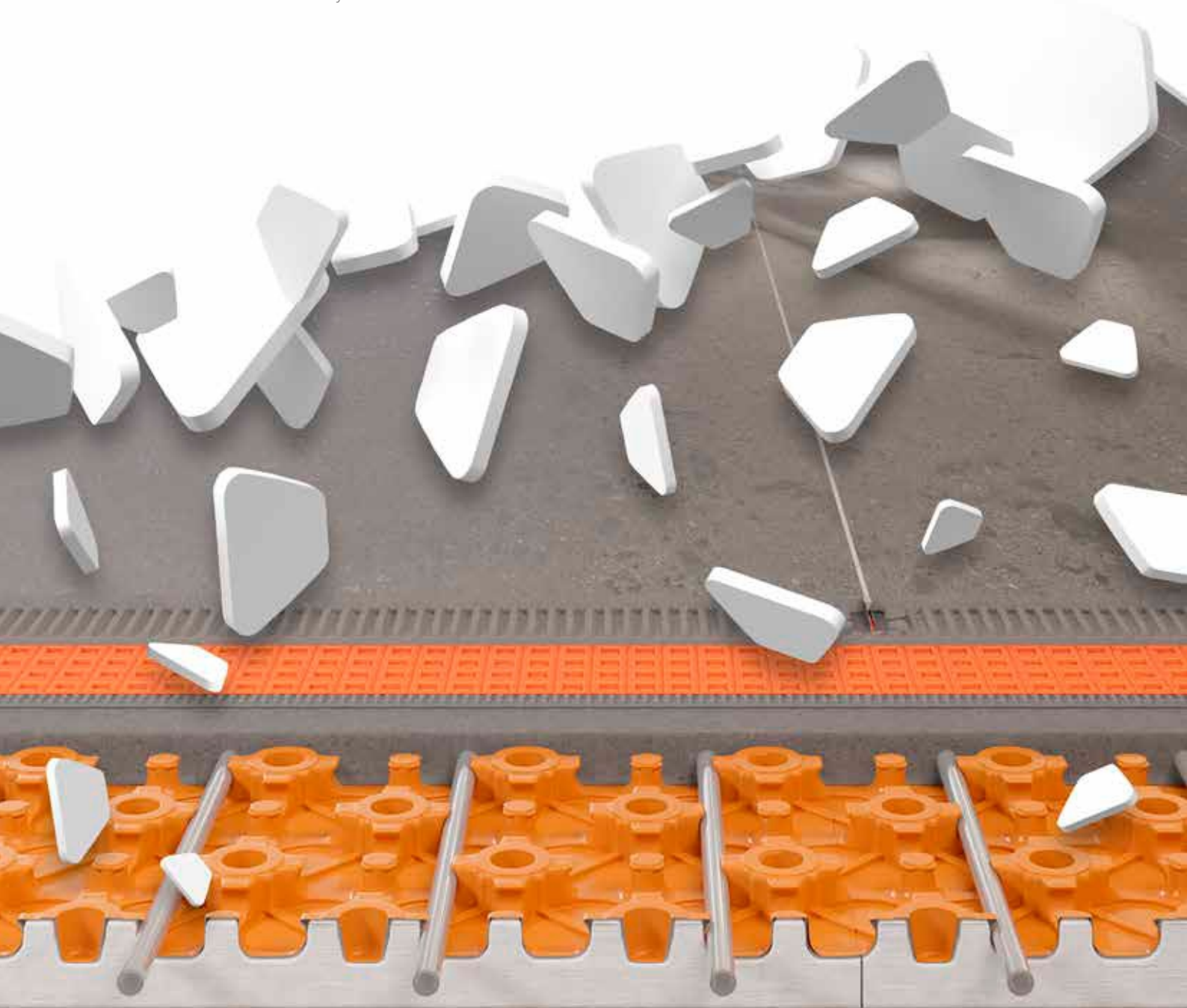

2025



All benefits of our floor heating system...

Saves energy
Sound-insulating
Dependable
Thermally insulating
Saves time
Heating and cooling
Durable
Hypo-allergenic
Cost-efficient
Comfortable
Creates pleasant room climate
Waterproof
Simple



... at a glance

Contents	Page
Schlüter-BEKOTEC-THERM	4
Energy efficiency	5
Living in the comfort zone	6
Advantages of Schlüter-BEKOTEC-THERM	8
Where to find help	9
Schlüter-BEKOTEC-THERM – system assembly	10
Regulating your comfort zone	12
Schlüter-BEKOTEC-THERM-FRS/-RTB	14
Schlüter-BEKOTEC-THERM – system solutions	16
Schlüter-BEKOTEC system FI	18
Schlüter-BEKOTEC system P/PF	20
Schlüter-BEKOTEC system F/F-PS	22
Schlüter-BEKOTEC system FTS	26
Schlüter-BEKOTEC system FK/FK-PS	28
Connection packages	
for heating pipe Ø 16 mm	32
for heating pipe Ø 14 mm	33
for heating pipe Ø 12 mm	34
for heating pipe Ø 10 mm	35
Renovation sets	
Schlüter-BEKOTEC-EN-F	36
Schlüter-BEKOTEC-EN-FK	37
Accessories	38
Additional system components	56
Calculation aids	62
Schlüter-BEKOTEC-THERM – online	65
Key	66
General business terms	67





Schlüter®-BEKOTEC-THERM

Ceramic thermal comfort floor

Schlüter-BEKOTEC-THERM is an innovative solution for building heated and/or cooled floors. Our covering assembly technology comprises a small number of simple components that can generally be installed with a conventional screed. Our proven studded panels enable quick installation without costly, special construction materials – ceramic tile coverings can typically be installed just one day after installing the screed.

The innovative assembly reduces modular tensions in the screed between the individual studs. The advantage for you: NO control joint profiles in the screed, NO buckling, very short curing periods. No high strength or rapid curing screeds are required; you only need our system components and a CT/CA C20–C35 / F4 max. F5 quality screed.

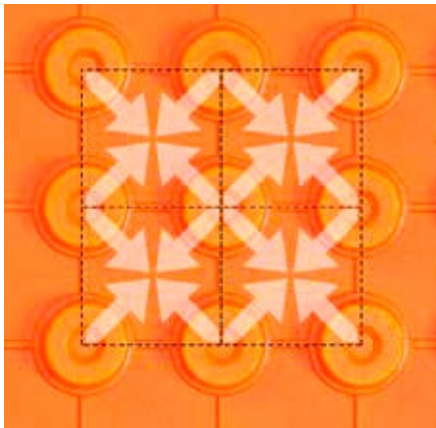

The innovative assembly reduces modular tensions in the screed between the individual studs. The advantage for you: NO control joint profiles in the screed, NO buckling, very short curing periods.

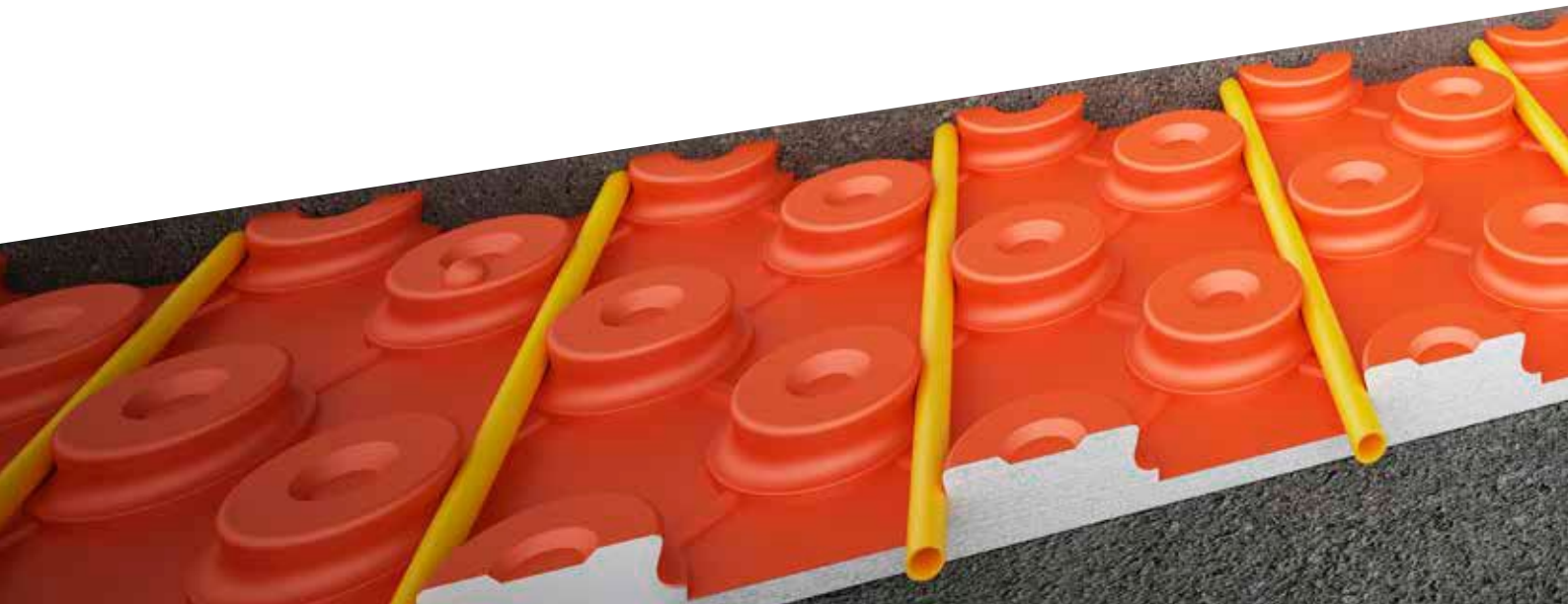

Energy efficiency

Scientifically proven

Due to the low assembly height, floor assemblies built with Schlüter-BEKOTEC-THERM are ideally suited for heating and cooling. The low system mass is able to quickly respond to temperature changes in the daytime and allows for effective room temperature reductions at night for energy efficiency.

A practical scientific test conducted by ITG Dresden has documented that Schlüter-BEKOTEC-THERM can save up to 9.5% of energy compared to conventional floor heating systems.

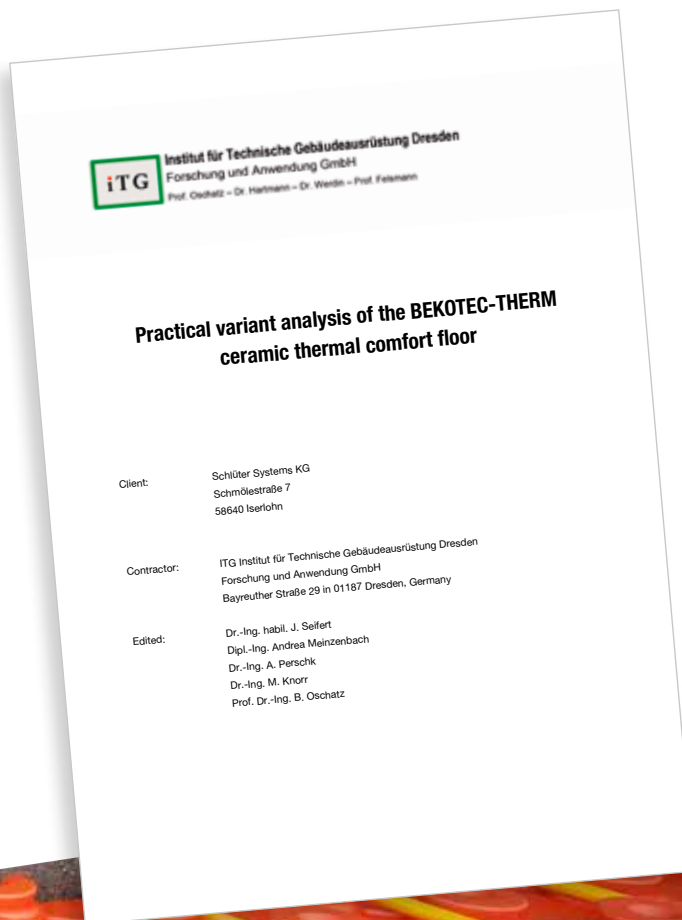

FIND OUT MORE AT:

BEKOTEC-THERM.CO.UK



Living in the comfort zone

Warms you when it's cold...

Schlüter-BEKOTEC-THERM is a thin-layered system. It can be operated with low supply temperatures because only a thin layer of screed needs to be heated.

The system is therefore particularly well suited for combination with renewable energy sources such as heat pumps. That saves resources, protects the environment – and cuts cost in the long term.

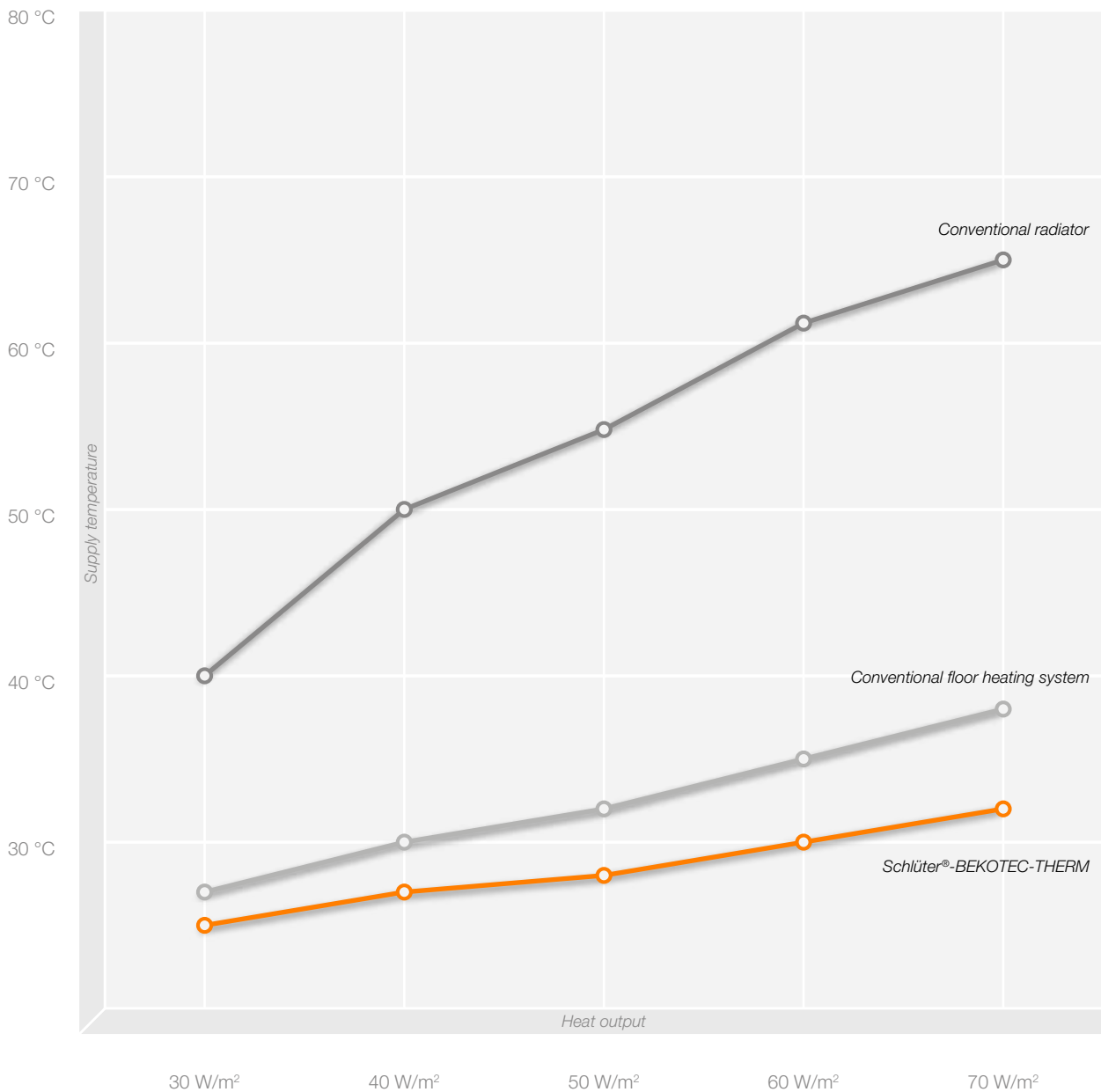
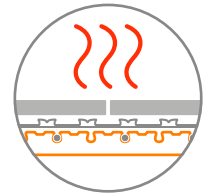

...and cools you when it's hot

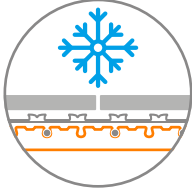

Do you have a heat pump that can also provide cooling? With the low supply (cooling) temperatures of BEKOTEC-THERM, you can efficiently provide passive cooling for your home – without a costly air conditioning system or additional technology. That keeps your home pleasantly cool even when it's hot outside.

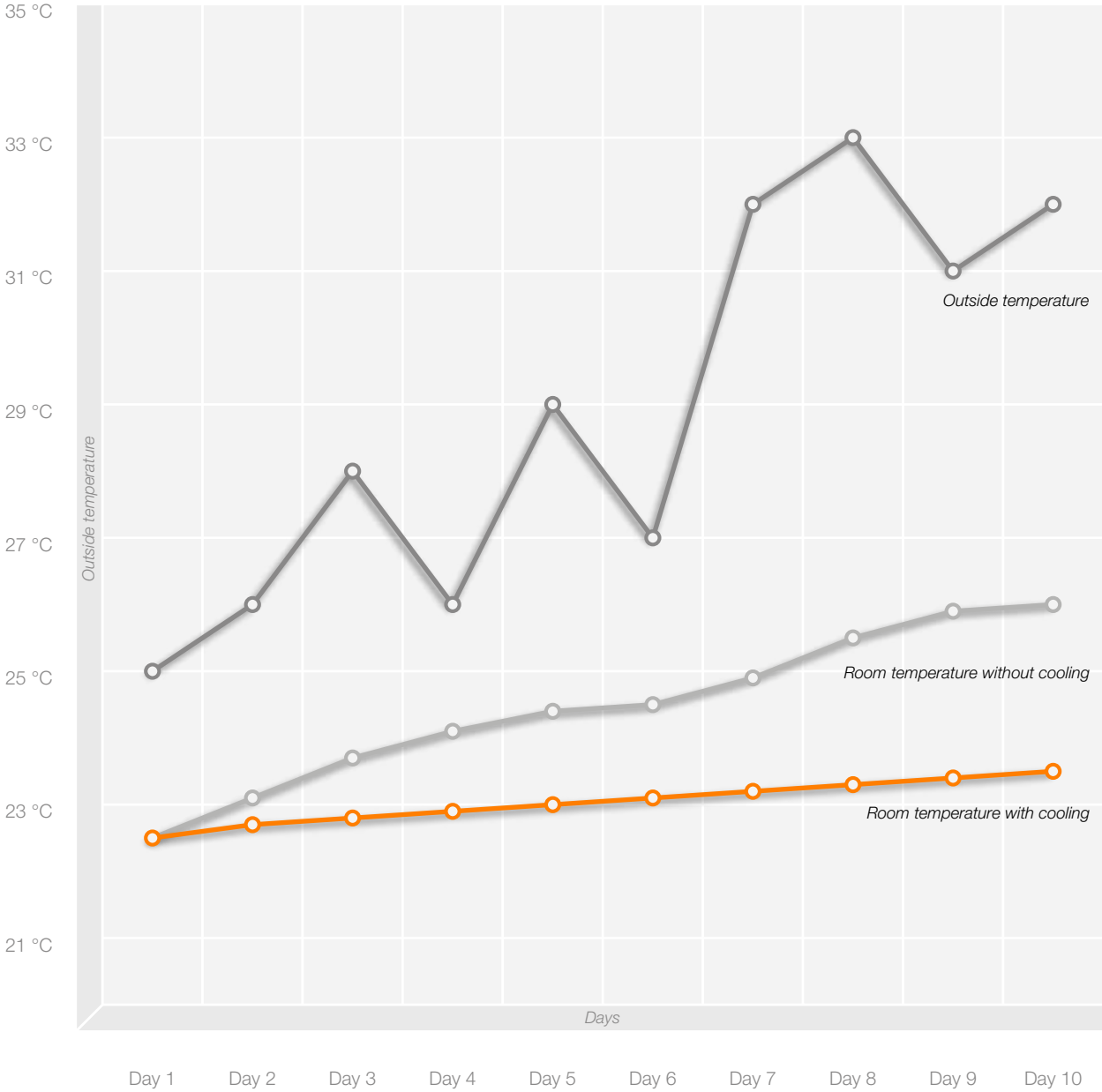

The diagrams are for illustration only and do not represent precise values.

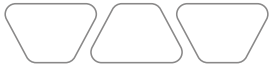

Advantages of Schlüter®-BEKOTEC-THERM

You will love it



Simple

The installation of Schlüter-BEKOTEC-THERM does not require complex components or expensive construction materials. All you need is simple technology, proven for decades. You can start heating the screed just 7 days after installing the ceramic/natural stone tile covering. Depending on the supply temperature, the heat curing phase only takes 2–3 days (start with a water temperature of 25 °C, then gradually increase the temperature by up to 5 °C a day until the supply temperature has been reached).



Safe

Are you planning to install a ceramic tile covering? Great! BEKOTEC-THERM keeps ceramic coverings permanently crack-free – starting from tile formats of 5 x 5 cm, without any size limitation. That means you can safely install and maintain stylish large formats free of damage. Another advantage: BEKOTEC-THERM is virtually buckle-free, which relegates torn skirting joints to the past.



Fast

If using conventional cementitious screed and ceramic tile coverings, there is no need to measure or reach specific residual moisture levels. Your tile installation can start as soon as the screed is ready to bear weight. Without complex and expensive special construction materials, your customer will be able to move in 28 days earlier, which saves time and money.



Easy

The BEKOTEC-THERM system does not require joints in the screed (except for structural expansion joints etc.). The control joints in the top covering specified by the relevant guidelines can therefore be positioned independent of the screed. That eliminates unsightly joints in the tile pattern and creates results that speak for themselves.



Sustainable

Due to its low assembly height, the BEKOTEC-THERM system can be operated with low supply temperatures. That makes it an excellent fit for combined use with sustainable, modern heat pumps. As an added benefit, the lower screed volume also decreases the consumption of resources such as sand and cement, which significantly lowers the ecological footprint.



System warranty

Schlüter-Systems offer an expanded, project-specific warranty for users of the BEKOTEC-THERM floor covering assembly. It includes sufficient weight bearing ability and cracks forming in coverings made of ceramic tiles, natural stone or synthetic stone.

To qualify for the warranty, BEKOTEC-THERM systems must be installed in accordance with the relevant product data sheets and the specifications of Schlüter-Systems.

Questions? Our sales team will be pleased to assist you!

E-Mail: sales@schluter.co.uk or Tel. 01530 813396

Where to find help

We are happy to help

Technical consulting

Our Technical Department will be happy to assist with any questions you may have concerning the assembly and the corresponding heating and control technology. Consultation on bespoke designs and solutions for your project are available on request.

Schlüter-BEKOTEC-THERM has been tested and approved for use with multiple tile adhesives (technical approval in Germany, ABP), light-weight screeds, etc. Depending on the construction project, special arrangements and additional tests are available on request.

Heating load calculation

We use a special software solution to precisely determine the heating load of buildings and individual rooms on the basis of the corresponding drawings and data in order to guarantee optimum heat distribution of the BEKOTEC-THERM ceramic thermal comfort floor.

Tender information

We can provide customised tender information and material requirements based on a technical design of our BEKOTEC-THERM radiant heating system. Additional information is also available online at our dedicated Schlüter-BEKOTEC-THERM website.

On site consulting

Please contact our offices if you need professional advice onsite. We will be pleased to arrange an appointment – for BEKOTEC-THERM and more.

Schlüter-Systems training

Our company offers training and workshops with particular focus on BEKOTEC-THERM for tradespeople, installation companies and sales staff. Please contact us to find out more about these events!



Schlüter®-BEKOTEC-THERM

System assembly overview

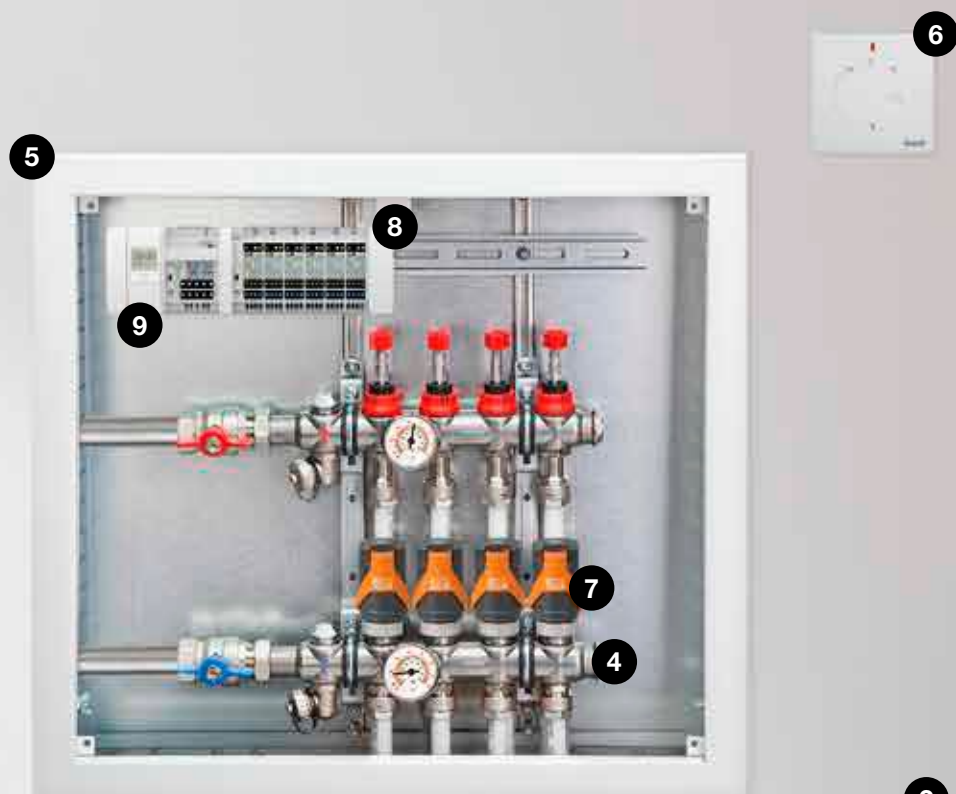

System components

Representative for all BEKOTEC systems

- 1. Schlüter®-BEKOTEC-EN**
Studded screed panel for the attachment of Schlüter heating pipes
- 2. Schlüter®-BEKOTEC-BRS**
Screed edge strip
- 3. Schlüter®-BEKOTEC-THERM-HR**
Heating pipe
- 4. Schlüter®-BEKOTEC-THERM-HV**
Stainless steel heating circuit distributor manifolds with connection accessories
- 5. Schlüter®-BEKOTEC-THERM-VS**
Distributor cabinet
- 6. Schlüter®-BEKOTEC-THERM-ER**
Room sensor
- 7. Schlüter®-BEKOTEC-THERM-EAHB**
Actuator
- 8. Schlüter®-BEKOTEC-THERM-EBC**
"Control" base module with connection module
- 9. Schlüter®-BEKOTEC-THERM-EET**
Timer unit (optional)
- 10. Schlüter®-DITRA**
Bonded waterproofing, uncoupling, vapour pressure equalisation, heat distribution

Additional system components can be found from page 56.



Regulating your comfort zone

Flexible control technology in three steps



1.1 Room sensor, wireless

OR



1.2 Room sensor, wired



2.1 "Control" base module



2.2 Timer unit

1

1.1

ER/WL – room sensor, wireless

Room sensor for wireless temperature control. The device wirelessly transmits the current room temperature and the setpoint value to the EAR/WL connection module.

1.2

ER – room sensor, wired

Room sensor for wired temperature control. The device transmits the current room temperature and the setpoint value to the EAR connection module.

2

2.1

EBC – "Control" base module

Base unit for operating the room temperature control. The wireless and wired connection modules for the room sensors are connected to the "Control" base module, which makes it easy to realise mixed installations and upgrades as well. The base module supplies the wired room sensors with 5 V ultra-low voltage via the respective connection modules and controls the connected actuators with 230 V AC.

2.2

EET – timer unit

The optional EET timer unit is used for time control of the temperature reduction (set-back). It can be removed from the "Control" base module to manually program the temperature reduction and plugged back in. A temperature reduction (set-back) of 4 °C is then effected in the timed periods.

Due to the responsiveness of the BEKOTEC-THERM ceramic thermal comfort floor, the timer unit meets the requirements for quickly controllable systems as specified in the German Energy Savings Regulation (EnEV).



2.3 Connection module, wireless



3.1 Actuators EAHB



OR



OR



2.4 Connection module, wired



3.2 Actuators ESA

2.3

EAR/WL – connection module, wireless

Modules for connecting 2 or 6 ER/WL wireless room sensors. The connection modules can simply be plugged together. This allows for easy adjustment and expanding the number of rooms/heating circuits to be regulated and the matching actuators. Each channel of the connection module can be assigned to 4 actuators. Combination with wired EAR connection modules is also possible.

2.4

EAR – connection module, wired

Modules for connecting 2 or 6 ER wired room sensors. The connection modules can simply be plugged together. This allows for easy adjustment and expanding the number of rooms/heating circuits to be regulated and the matching actuators. Each channel of the connection module can be assigned to 4 actuators. Combination with wireless EAR/WL connection modules is possible.

3

3.1

EAHB – actuator

The EAHB actuators for intelligent, adaptive hydronic balancing allow for optimum energy efficiency depending on the hot leg and cold leg temperature of the heating circuit.

3.2

ESA – actuator

The ESA actuators typically regulate the flow at the individual cold leg valves of the heating circuit distributor based on thermostat settings. The static hydronic balancing occurs at the distributor.

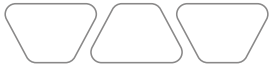

Schlüter®-BEKOTEC-THERM-FRS

The optimal supply temperature for your home

Are you planning to renovate several rooms or a complete home, including a floor heating system? Do you want to achieve this without having to remodel your entire heating system? Then Schlüter-BEKOTEC-THERM-FRS is the right solution for you. The system is designed for connecting BEKOTEC-THERM to a conventional heating system without any changes to the system technology.

Our fixed-value control station reduces the supply temperature for BEKOTEC-THERM and uses the integrated high-efficiency pump to ensure that all heating circuits are optimally supplied without overloading the existing heating system. Used with our heating circuit distributors and distributor cabinets, the system is ideally suited for renovations in existing buildings.

Simple is best!

Our intelligent Schlüter-BEKOTEC-THERM-FRS makes it feasible to install floor heating systems virtually anywhere.

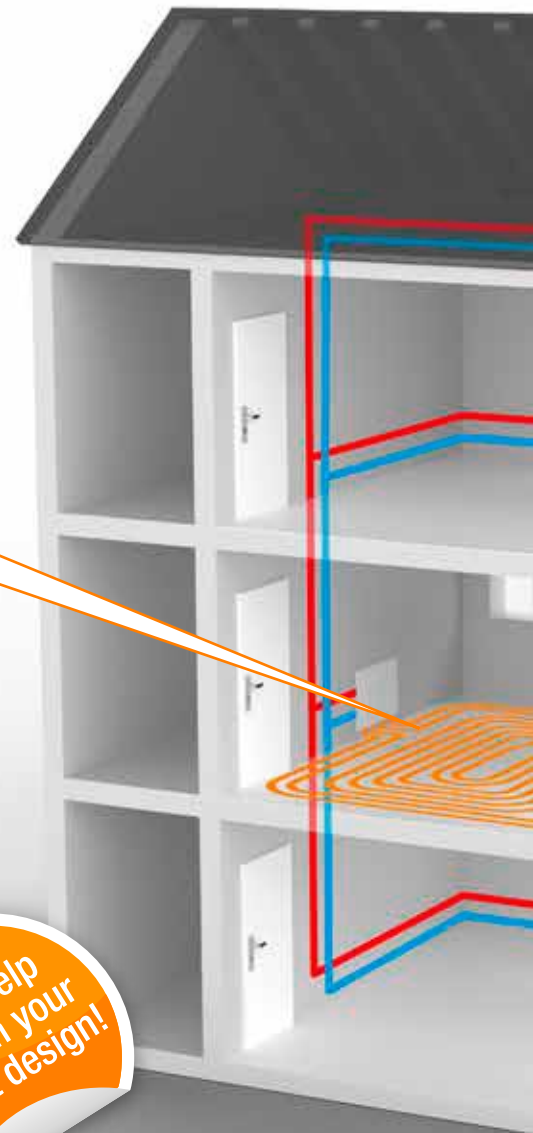

Schlüter®-BEKOTEC-THERM-RTB

Perfectly adapted to use in individual rooms

Are you planning to renovate individual rooms to enjoy the comfort of a floor heating system in spaces that were previously heated with conventional radiators? In that case, our Schlüter-BEKOTEC-THERM-RTB return temperature limiter is the ideal solution for you. It limits the high supply temperatures of your existing heating system to make them suitable for use with BEKOTEC-THERM.

In existing buildings with high heating loads, the return temperature limiter achieves comfortable floor heating in combination with the existing radiator.

In existing buildings with medium to low heating loads, simply connect the return temperature limiter with room temperature control to a stand-alone floor heating system – no additional radiator is required.



What a combination!

Our floor heating system can easily be combined with your existing heating system.

Everything under control!

Schlüter-BEKOTEC-THERM-RTB automatically reduces the return temperature of your new floor heating system without any additional auxiliary energy.

Individually adjustable!

Retrofit to your new floor heating system – including individual rooms.

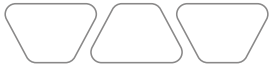

Schlüter®-BEKOTEC-THERM

New construction or renovation:
The right system solution for every need

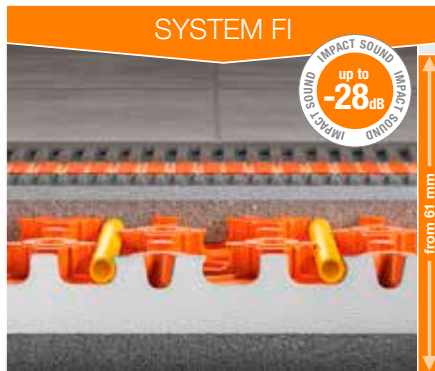

The quiet type with insulation

Schlüter®-BEKOTEC-EN-FI

With 30 mm heat and sound insulation (DES 039 /CP 2) for use in areas with heat insulation requirements, e.g. on foundation slabs.

- ✓ **Assembly heights:** 61 – 78 mm (plus DITRA uncoupling membrane)
- ✓ **With integrated heat and sound insulation; can be combined with additional heat insulation materials**
- ✓ **Weight per unit area** from 58 kg/m²
- ✓ **75 mm installation grid** (minimum pipe spacing)
- ✓ **Heat output** up to 100 W/m²

More details from page 18

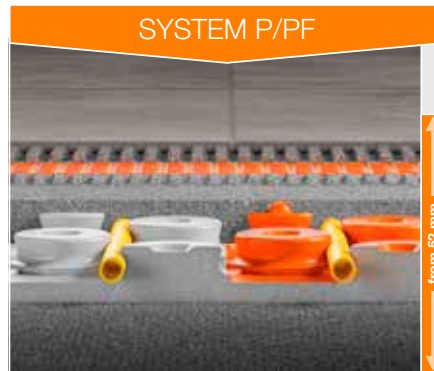

The insulated type

Schlüter®-BEKOTEC-EN-P/-PF

With integrated insulation (DEO 033) for use in areas with thermal insulation requirements, e.g. base plate.

- ✓ **Assembly heights:** 52 – 69 mm (plus DITRA uncoupling membrane)
- ✓ **With integrated heat insulation; can be combined with additional insulation materials**
- ✓ **Weight per unit area** from 57 kg/m²
- ✓ **75 mm installation grid** (minimum pipe spacing)
- ✓ **Heat output** up to 100 W/m²

More details from page 20



The all-round talent

Schlüter®-BEKOTEC-EN-F/-F-PS

Universal assembly for use with and without (sound impact) insulation. Low assembly height, ideal for new construction and renovation.

- ✓ **Assembly heights:** 31 – 48 mm (plus DITRA uncoupling membrane)
- ✓ **Without insulation; can be combined with insulation materials**
- ✓ **Weight per unit area** from 57 kg/m²
- ✓ **75 mm installation grid** (minimum pipe spacing)
- ✓ **Heat output** up to 100 W/m²
- ✓ **Also available in a self-adhesive (Peel & Stick) version**

More details from page 22

Also available as a set



The quiet type

Schlüter®-BEKOTEC-EN-FTS

Our system achieves a sound insulation improvement of up to 25 dB according to DIN EN ISO 10140-1 to optimise impact sound.

- ✓ **Assembly heights:**
31 – 43 mm (plus DITRA uncoupling membrane)
- ✓ **Integrated impact sound insulation**
- ✓ **Weight per unit area**
from 52 kg/m²
- ✓ **50 mm installation grid**
(minimum pipe spacing)
- ✓ **Heat output**
up to 100 W/m²

More details from page 26

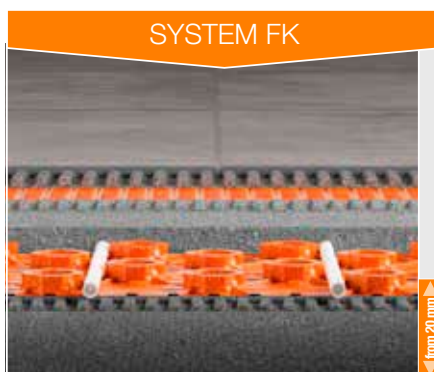

The lightweight type

Schlüter®-BEKOTEC-EN-FK/-FK-PS

Our lightest and thinnest assembly is the best choice for minimal weight. Please contact us if you need options for further assembly weight reduction.

- ✓ **Assembly heights:**
20 – 27 mm (plus DITRA uncoupling membrane)
- ✓ **Adhered to substrate**
- ✓ **Weight per unit area**
from 40 kg/m²
- ✓ **50 mm installation grid**
(minimum pipe spacing)
- ✓ **Heat output**
up to 100 W/m²
- ✓ **Also available in a self-adhesive (Peel & Stick) version**

More details from page 28

Also available as a set

Information

Ceramic tile and natural stone

Additional uncoupling with DITRA, DITRA-HEAT or DITRA-DRAIN is required for installing ceramic tiles or natural stone.

Parquet, laminate and carpeting

Please note the installation instructions and our technical data sheets for the installation of parquet, laminate, LVT and carpeting.



Schlüter®-BEKOTEC-EN-FI

The quiet type with insulation

Technical system details

System height (incl. DITRA)	66 – 83 mm
Studded screed panel height	53 mm
Screed coverage	8 – 25 mm
Pipe diameter	14 x 2 mm 16 x 2 mm
Pipe installation spacing	75 150 225 300 mm
Heating pipe requirements	13.33 6.66 4.44 3.33 m/m ²
Max. heat output (VT 40 °C / RT 20 °C)*	14 mm: 130 90 50 40 W/m ² 16 mm: 140 100 60 40 W/m ²
Min. weight per unit area	58 kg/m ²
Min. screed volume	28.5 l/m ²
Max. traffic load	up to 5 kN/m ²

* VT = supply temperature / RT = room temperature

Technical details on the studded screed panel

Working area	120 x 90 cm = 1.08 m ²
Notes about insulation	integrated thermal and sound insulation DES 039 / U value 1.30 W/m ² K / CP2

Note:

The uncoupling mat Schlüter-DITRA must be adhered to the screed prior to the installation of ceramic tiles or natural stone on the screed. The mat can be installed as soon as the screed is ready to bear weight (gypsum screeds: < 2 % residual moisture).

Please observe the instructions of our product data sheets 6.1 and 9.8.

Further information can be found in our Technical Manual.

Studded screed panel

Schlüter®-BEKOTEC-EN-FI

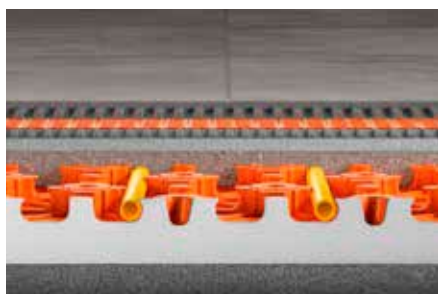

Schlüter-BEKOTEC-EN-FI is a studded screed panel made of high impact polystyrene with a 30 mm heat and sound insulation layer made of EPS, designed for the attachment of Schlüter heating pipes (Ø 14/16 mm). The cut back studs hold the heating pipe in a defined pattern (75 mm grid). The BEKOTEC panels are connected by overlapping a row of studs and clicking the panels together. A minimum coverage of 8 mm (max. 25 mm), using a commercial cement or gypsum screed (compressive strength C20–C35 / flexural strength F4 max. F5) and the BEKOTEC-THERM-HR heating pipes make sure that system coverings made of ceramic tile and natural stone remain permanently crack-free. Please refer to our Technical Manual for coverings and installations made of alternative materials.

Schlüter®-BEKOTEC-EN 23 FI 30

studded screed panel with 30 mm heat and sound insulation

Art. No.	€/ m ²	P (Unit)
EN 23 FI 30	29.95	16

1 panel (1.08 m²) = smallest delivery unit

Edging strip:

The edging strips BRS 810 / BRSK 810 / BRS 808 KF or BRS 808 KSF must be used with the studded screed panel EN 23 FI 30 (see page 38).

Heating pipe

Schlüter®-BEKOTEC-THERM-HR



Schlüter-BEKOTEC-THERM-HR is a 5-ply bonded heating pipe made of a high-quality polymer material (PE-RT) with an oxygen diffusion barrier in the centre. The highly flexible heating pipe, which complies with DIN 16833, is optimised for installation in BEKOTEC system panels. Its oxygen tightness is certified according to DIN 4726, and the product is subject to continuous quality monitoring.

Schlüter®-BEKOTEC-THERM-HR

heating pipe 14 x 2 mm for EN 23 FI 30

L (m)	Art. No.	€/ m	P (Roll)
70	BTHR 14 RT 70	2.03	7
120	BTHR 14 RT 120	2.03	7
200	BTHR 14 RT 200	2.01	7
600	BTHR 14 RT 600	2.01	4

Schlüter®-BEKOTEC-THERM-HR

heating pipe 16 x 2 mm for EN 23 FI 30

L (m)	Art. No.	€/ m	P (Roll)
70	BTHR 16 RT 70	2.07	7
120	BTHR 16 RT 120	2.07	7
200	BTHR 16 RT 200	2.05	7
600	BTHR 16 RT 600	2.05	4

Levelling panel

Schlüter®-BEKOTEC-ENFGI



The levelling panel Schlüter-BEKOTEC-ENFGI with heat and sound insulation is installed in front of heating circuit distributors to simplify the heating pipe installation in the distributor cabinet.

Schlüter®-BEKOTEC-ENFGI 30

levelling panel with 30 mm heat and sound insulation for EN 23 FI 30

Art. No.	€/ U.	P (Unit)
ENFGI 30	34.95	10

Working area: 120 x 90 cm = 1.08 m²

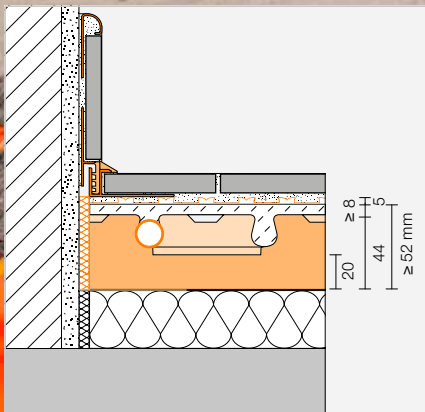

Schlüter®-BEKOTEC-EN-P/-PF

The insulated type

Technical system details

System height (incl. DITRA)	57 – 74 mm
Studded screed panel height	44 mm
Screed coverage	8 – 25 mm
Pipe diameter	16 x 2 mm
Pipe installation spacing	75 150 225 300 mm
Heating pipe requirements	13.33 6.66 4.44 3.33 m/m ²
Max. heat output (VT 40 °C / RT 20 °C)*	140 100 60 40 W/m ²
Min. weight per unit area	57 kg/m ²
Min. screed volume	28.5 l/m ²
Max. traffic load	up to 5 kN/m ²

* VT = supply temperature / RT = room temperature

Technical details on the studded screed panel

Working area	75.5 x 106 cm = 0.8 m ²
Notes about insulation	integrated DEO 033 / U value: 1.650 W/m ² K

Note:

The uncoupling mat Schlüter-DITRA must be adhered to the screed prior to the installation of ceramic tiles or natural stone on the screed. The mat can be installed as soon as the screed is ready to bear weight (gypsum screeds: < 2 % residual moisture).

Please observe the instructions of our product data sheets 6.1 and 9.1.

Further information can be found in our Technical Manual.

Studded screed panel

Schlüter®-BEKOTEC-EN-P/-PF

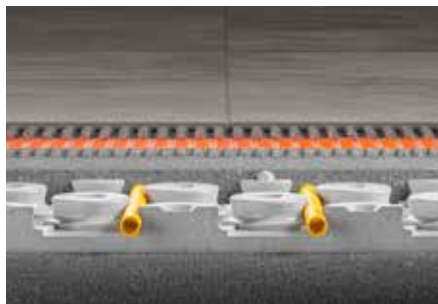

Schlüter-BEKOTEC-EN-P/-PF is a studded screed panel designed for the attachment of Schlüter heating pipes with a diameter of 16 mm. The panels are grooved for clean, reliable and simple joining. The cut back studs hold the heating pipe in a defined pattern (75 mm grid). A minimum coverage of 8 mm (max. 25 mm), using a commercial cement or gypsum screed (compressive strength C20–C35 / flexural strength F4 max. F5) and the BEKOTEC-THERM-HR heating pipes make sure that system coverings made of ceramic tile and natural stone remain permanently crack-free. Please refer to our Technical Manual for coverings and installations made of alternative materials.

Schlüter®-BEKOTEC-EN-P

studded screed panel without foil coating

Art. No.	€ / m ²	P (Unit)
EN 2520 P	20.56	20

1 panel (0.8 m²) = smallest delivery unit

Note:

Material: Polystyrene (EPS 033, DEO = insulation for screed without sound insulation requirements). Suitable for use with conventional sand and cement screeds.

Schlüter®-BEKOTEC-EN-PF

studded screed panel with foil coating

Art. No.	€ / m ²	P (Unit)
EN 1520 PF	24.67	20

1 panel (0.8 m²) = smallest delivery unit

Note:

Material: Polystyrene (EPS 033, DEO = insulation for screed without sound insulation requirements). With polystyrene foil coating for use in flowing screeds (e.g. gypsum screeds).

Edging strip:

EN 2520 P: BRS 810 / BRSK 810 / BRS 808 KF / BRS 808 KSF
EN 1520 PF: BRS 808 KF / BRS 808 KSF (see page 38)

Heating pipe

Schlüter®-BEKOTEC-THERM-HR



Schlüter-BEKOTEC-THERM-HR is a 5-ply bonded heating pipe made of a high-quality polymer material (PE-RT) with an oxygen diffusion barrier in the centre. The highly flexible heating pipe, which complies with DIN 16833, is optimised for installation in BEKOTEC system panels. Its oxygen tightness is certified according to DIN 4726, and the product is subject to continuous quality monitoring.

Our systems have been tested according to DIN EN 1264.

Schlüter®-BEKOTEC-THERM-HR

heating pipe 16 x 2 mm for EN-P and EN-PF

L (m)	Art. No.	€ / m	P (Roll)
70	BTHR 16 RT 70	2.07	7
120	BTHR 16 RT 120	2.07	7
200	BTHR 16 RT 200	2.05	7
600	BTHR 16 RT 600	2.05	4

Levelling panel

Schlüter®-BEKOTEC-ENR



Schlüter-BEKOTEC-ENR is a levelling panel to reduce cutting waste in edge areas and transitions (e.g. doors, niches), for areas in which no heating pipes are installed. It can also be used in front of heating circuit distributors to facilitate heating pipe installation.

Schlüter®-BEKOTEC-ENR

levelling panel for EN-P and EN-PF

Art. No.	€ / U.	P (Unit)
ENR 1520 P	2.44	20

Working area: 30.5 x 45.5 cm = 0.14 m²



Schlüter®-BEKOTEC-EN-F

The all-round talent

Technical system details

System height (incl. DITRA)	36 – 53 mm
Studded screed panel height	23 mm
Screed coverage	8 – 25 mm
Pipe diameter	14 x 2 mm
Pipe installation spacing	75 150 225 300 mm
Heating pipe requirements	13.33 6.66 4.44 3.33 m/m ²
Max. heat output (VT 40 °C / RT 20 °C)*	130 90 50 40 W/m ²
Min. weight per unit area	57 kg/m ²
Min. screed volume	28.5 l/m ²
Max. traffic load	up to 5 kN/m ²

* VT = supply temperature / RT = room temperature

Technical details on the studded screed panel

Working area	120 x 90 cm = 1.08 m ²
Notes about insulation	DEO / DES possible

Note:

The uncoupling mat Schlüter-DITRA must be adhered to the screed prior to the installation of ceramic tiles or natural stone on the screed. The mat can be installed as soon as the screed is ready to bear weight (gypsum screeds: < 2 % residual moisture).

Please observe the instructions of our product data sheets 6.1 and 9.2.

Further information can be found in our Technical Manual.

Studded screed panel

Schlüter®-BEKOTEC-EN-F



Schlüter-BEKOTEC-EN-F is a studded screed panel made of high impact polystyrene, designed for the attachment of Schlüter heating pipes (Ø 14 mm). The BEKOTEC panels are connected by overlapping a row of studs and clicking the panels together. The cut back studs hold the heating pipe in a defined pattern (75 mm grid). A minimum coverage of 8 mm (max. 25 mm), using a commercial cement or gypsum screed (compressive strength C20–C35 / flexural strength F4 max. F5) and the BEKOTEC-THERM-HR heating pipes make sure that system coverings made of ceramic tile and natural stone remain permanently crack-free. Please refer to our Technical Manual for coverings and installations made of alternative materials.

Schlüter®-BEKOTEC-EN 23 F

studded screed panel

Art. No.	€ / m ²	P (Unit)
EN 23 F	19.36	20

1 panel (1.08 m²) = smallest delivery unit

Note:

The BEKOTEC-EN-F system can be installed with thermal or sound impact insulation. Further details on these assemblies can be found in our Technical Manual.

Edging strip:

The edging strip BRS 808 KSF must be used with studded screed panels EN 23 F (see page 38).

Heating pipe

Schlüter®-BEKOTEC-THERM-HR



Schlüter-BEKOTEC-THERM-HR is a 5-ply bonded heating pipe made of a high-quality polymer material (PE-RT) with an oxygen diffusion barrier in the centre. The highly flexible heating pipe, which complies with DIN 16833, is optimised for installation in BEKOTEC system panels. Its oxygen tightness is certified according to DIN 4726, and the product is subject to continuous quality monitoring.

Schlüter®-BEKOTEC-THERM-HR

heating pipe 14 x 2 mm for EN 23 F

L (m)	Art. No.	€ / m	P (Roll)
70	BTHR 14 RT 70	2.03	7
120	BTHR 14 RT 120	2.03	7
200	BTHR 14 RT 200	2.01	7
600	BTHR 14 RT 600	2.01	4

Our systems have been tested according to DIN EN 1264.

Levelling panel

Schlüter®-BEKOTEC-ENFG



The levelling panel Schlüter-BEKOTEC-ENFG is installed in front of heating circuit distributors to simplify the heating pipe installation in the distributor cabinet. The polystyrene panel is adhered to the studded panel with the supplied double sided adhesive tape (6 m).

Schlüter®-BEKOTEC-ENFG

levelling panel set for EN 23 F

Art. No.	€ / Set	P (Set)
ENFG	30.17	10

Working area: 127.5 x 97.5 cm = 1.24 m²

Set includes:

- 1 levelling panel
- 6 m double sided adhesive tape

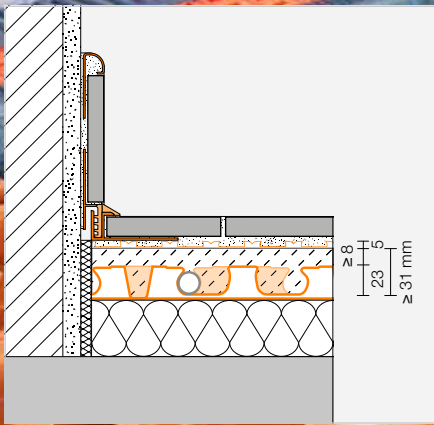

Schlüter®-BEKOTEC-EN-F-PS

The all-round talent – now in a self-adhesive version too

Technical system details

System height (incl. DITRA)	36 – 53 mm
Studded screed panel height	23 mm
Screed coverage	8 – 25 mm
Pipe diameter	14 x 2 mm 16 x 2 mm
Pipe installation spacing	75 150 225 300 mm
Heating pipe requirements	13.33 6.66 4.44 3.33 m/m ²
Max. heat output (VT 40 °C / RT 20 °C)*	14 mm: 130 90 50 40 W/m ² 16 mm: 140 100 60 40 W/m ²
Min. weight per unit area	57 kg/m ²
Min. screed volume	28.5 l/m ²
Max. traffic load	up to 5 kN/m ²

* VT = supply temperature / RT = room temperature

Technical details on the studded screed panel

Working area	120 x 90 cm = 1.08 m ²
Notes about insulation	DEO / DES possible

Note:

The uncoupling mat Schlüter-DITRA must be adhered to the screed prior to the installation of ceramic tiles or natural stone on the screed. The mat can be installed as soon as the screed is ready to bear weight (gypsum screeds: < 2 % residual moisture).

Please observe the instructions of our product data sheets 6.1 and 9.6.

Further information can be found in our Technical Manual.

Studded screed panel

Schlüter®-BEKOTEC-EN-F-PS



Schlüter-BEKOTEC-EN-F-PS is a studded screed panel made of high impact polystyrene, designed for the attachment of Schlüter heating pipes (Ø 14/16 mm) with a self-adhesive backing. The studded panel is installed on suitable substrates after peeling off the release film. The cut back studs hold the heating pipe in a defined pattern (75 mm grid). The BEKOTEC panels are connected by overlapping a row of studs and clicking the panels together. A minimum coverage of 8 mm (max. 25 mm), using a commercial cement or gypsum screed (compressive strength C20–C35 / flexural strength F4 max. F5) and the BEKOTEC-THERM-HR heating pipes make sure that system coverings made of ceramic tile and natural stone remain permanently crack-free. Further information can be found in our Technical Manual.

Schlüter®-BEKOTEC-EN 23 F PS

self-adhesive studded screed panel

Art. No.	€ / m ²	P (Unit)
EN 23 F PS	26.50	20

1 panel (1.08 m²) = smallest delivery unit

Note:

The BEKOTEC-EN-F-PS system can be installed with heat or sound insulation. Depending on the substrate, Schlüter heating pipes (Ø 14/16 mm) can be installed; see product data sheet 9.6.

Edging strip:

The edging strip BRS 808 KSF must be used with studded screed panels EN 23 F PS (see page 38).

Heating pipe

Schlüter®-BEKOTEC-THERM-HR



Schlüter-BEKOTEC-THERM-HR is a 5-ply bonded heating pipe made of a high-quality polymer material (PE-RT) with an oxygen diffusion barrier in the centre. The highly flexible heating pipe, which complies with DIN 16833, is optimised for installation in BEKOTEC system panels. Its oxygen tightness is certified according to DIN 4726, and the product is subject to continuous quality monitoring.

Schlüter®-BEKOTEC-THERM-HR

heating pipe 14 x 2 mm for EN 23 F PS

L (m)	Art. No.	€ / m	P (Roll)
70	BTHR 14 RT 70	2.03	7
120	BTHR 14 RT 120	2.03	7
200	BTHR 14 RT 200	2.01	7
600	BTHR 14 RT 600	2.01	4

Schlüter®-BEKOTEC-THERM-HR

heating pipe 16 x 2 mm for EN 23 F PS

L (m)	Art. No.	€ / m	P (Roll)
70	BTHR 16 RT 70	2.07	7
120	BTHR 16 RT 120	2.07	7
200	BTHR 16 RT 200	2.05	7
600	BTHR 16 RT 600	2.05	4

Levelling panel

Schlüter®-BEKOTEC-ENFG-PS



The levelling panel Schlüter-BEKOTEC-ENFG-PS is installed in front of heating circuit distributors to simplify the heating pipe installation in the distributor cabinet. The panel has a self-adhesive backing covered with a release film.

Schlüter®-BEKOTEC-ENFG-PS

self-adhesive levelling panel for EN 23 F PS

Art. No.	€ / U.	P (Unit)
EN 23 FG PS	32.50	10

Working area: 127.5 x 97.5 cm = 1.24 m²

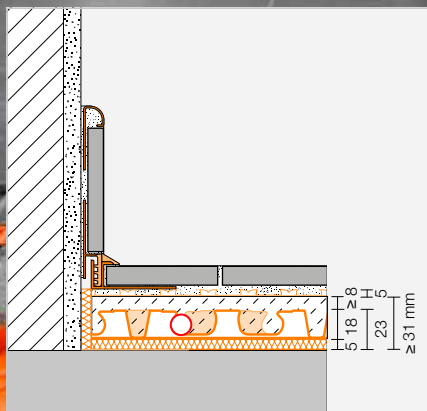

Schlüter®-BEKOTEC-EN-FTS

The quiet type

Technical system details

System height (incl. DITRA)	36 – 48 mm
Studded screed panel height	18 + 5 mm
Screed coverage	8 – 20 mm
Pipe diameter	12 x 1.5 mm
Pipe installation spacing	50 100 150 200 250 300 mm
Heating pipe requirements	20 10 6.66 5 4 3.33 m/m ²
Max. heat output (VT 40 °C / RT 20 °C)*	145 120 80 50 40 30 W/m ²
Min. weight per unit area	52 kg/m ²
Min. screed volume	26 l/m ²
Max. traffic load	up to 5 kN/m ²

* VT = supply temperature / RT = room temperature

Technical details on the studded screed panel

Working area	140 x 80 cm = 1.12 m ²
Notes about insulation	Improvement in sound insulation acc. to DIN EN ISO 10140-1: 25 dB

Note:

The uncoupling mat Schlüter-DITRA must be adhered over the screed prior to the installation of ceramic tiles or natural stone. The mat can be installed as soon as the screed is ready to bear weight (gypsum screeds: < 2 % residual moisture). Please observe the instructions of our product data sheets 6.1 and 9.4. Further information can be found in our Technical Manual.

Studded screed panel

Schlüter®-BEKOTEC-EN-FTS



Schlüter-BEKOTEC-EN-FTS is a studded screed panel made of impact resistant polystyrene with additional 5 mm impact sound insulation on the underside. The cut back studs hold the heating pipe in a defined pattern (50 mm grid). The BEKOTEC panels are connected by overlapping a row of studs and clicking the panels together. A minimum coverage of 8 mm (max. 20 mm), using a commercial cement or gypsum screed (compressive strength C20–C35 / flexural strength F4 max. F5) and the BEKOTEC-THERM-HR heating pipes make sure that system coverings made of ceramic tile and natural stone remain permanently crack-free. Please refer to our Technical Manual for coverings and installations made of alternative materials.

Schlüter®-BEKOTEC-EN 18 FTS

studded screed panel with impact sound insulation

Art. No.	€ / m ²	P (Unit)
EN 18 FTS 5	31.29	20

1 panel (1.12 m²) = smallest delivery unit

Improvement in sound insulation:

An evaluation in accordance with DIN EN ISO 10140-1 determined an impact sound insulation improvement of up to 25 dB for the studded panel EN 18 FTS.

Edging strip:

The edging strip BRS 808 KSF must be used with studded screed panels EN 18 FTS (see page 38).

Heating pipe

Schlüter®-BEKOTEC-THERM-HR



Schlüter-BEKOTEC-THERM-HR is a 5-ply bonded heating pipe made of a high-quality polymer material (PE-RT) with an oxygen diffusion barrier in the centre. The highly flexible heating pipe, which complies with DIN 16833, is optimised for installation in BEKOTEC system panels. Its oxygen tightness is certified according to DIN 4726, and the product is subject to continuous quality monitoring.

Schlüter®-BEKOTEC-THERM-HR

heating pipe 12 x 1.5 mm for EN 18 FTS

L (m)	Art. No.	€ / m	P (Roll)
70	BTHR 12 RT 70	1.94	8
120	BTHR 12 RT 120	1.94	8
200	BTHR 12 RT 200	1.91	8
600	BTHR 12 RT 600	1.91	5

Our systems have been tested according to DIN EN 1264.

Levelling panel

Schlüter®-BEKOTEC-ENFGTS

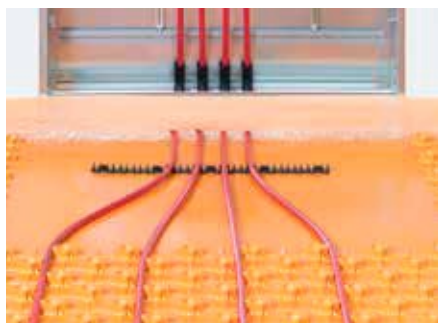

The levelling panel Schlüter-BEKOTEC-ENFGTS is installed in front of heating circuit distributors to simplify the heating pipe installation in the distributor cabinet. The polystyrene panel is adhered to the studded panel with the supplied double sided adhesive tape (6 m). To keep the heating pipe securely within the system, the same impact sound insulation is installed under the levelling panel as with EN 18 FTS.

Schlüter®-BEKOTEC-ENFGTS

levelling panel set for EN 18 FTS

Art. No.	€ / Set	P (Set)
EN 18 FGTS 5	43.31	10

Working area: 140 x 80 cm = 1.12 m²

Set includes:

- 1 levelling panel
- 6 m double sided adhesive tape



Schlüter®-BEKOTEC-EN-FK

The lightweight type

Technical system details

System height (incl. DITRA)	25 – 32 mm
Studded screed panel height	12 mm
Screed coverage	8 – 15 mm
Pipe diameter	10 x 1.3 mm
Pipe installation spacing	50 100 150 200 250 300 mm
Heating pipe requirements	20 10 6.66 5 4 3.33 m/m ²
Max. heat output (VT 40 °C / RT 20 °C)*	145 120 80 50 35 30 W/m ²
Min. weight per unit area	40 kg/m ²
Min. screed volume	20 l/m ²
Max. traffic load	up to 5 kN/m ²

* VT = supply temperature / RT = room temperature

Technical details on the studded screed panel

Working area	110 x 70 cm = 0.77 m ²
Notes about insulation	not suitable for use over an insulation layer

Note:

The uncoupling mat Schlüter-DITRA must be adhered over the screed prior to the installation of ceramic tiles or natural stone. The mat can be installed as soon as the screed is ready to bear weight (gypsum screeds: < 2 % residual moisture).

Please observe the instructions of our product data sheets 6.1 and 9.5.

Further information can be found in our Technical Manual.

Studded screed panel

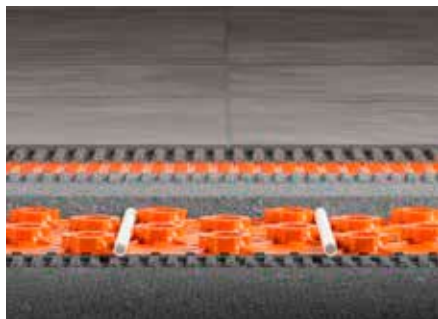
Schlüter®-BEKOTEC-EN-FK

Schlüter-BEKOTEC-EN-FK is a studded screed panel made of impact resistant polystyrene foil with an anchoring fleece laminated on the underside. It is fully embedded as a bonded assembly on suitable weight-bearing substrates. The cut back studs hold the heating pipe in a defined pattern (50 mm grid). The BEKOTEC panels are connected by overlapping a row of studs and clicking the panels together. A minimum coverage of 8 mm (max. 15 mm), using a commercial cement or gypsum screed (compressive strength C20–C35 / flexural strength F4 max. F5) and the BEKOTEC-THERM-HR heating pipes make sure that system coverings made of ceramic tile and natural stone remain permanently crack-free. Please refer to our Technical Manual for coverings and installations made of alternative materials.

Schlüter®-BEKOTEC-EN 12 FK

studded screed panel
with anchoring fleece on the underside

Art. No.	€ / m ²	P (Unit)
EN 12 FK	20.78	20

1 panel (0.77 m²) = smallest delivery unit

Edging strip:

The edging strip BRS 808 KSF must be used with studded screed panels EN 12 FK (see page 38).

Heating pipe

Schlüter®-BEKOTEC-THERM-HR

Schlüter-BEKOTEC-THERM-HR is a 5-ply bonded heating pipe made of a high-quality polymer material (PE-RT) with an oxygen diffusion barrier in the centre. The highly flexible heating pipe, which complies with DIN 16833, is optimised for installation in BEKOTEC system panels. Its oxygen tightness is certified according to DIN 4726, and the product is subject to continuous quality monitoring.

Schlüter®-BEKOTEC-THERM-HR

heating pipe 10 x 1.3 mm for EN 12 FK

L (m)	Art. No.	€ / m	P (Roll)
70	BTHR 10 RT 70	1.85	8
120	BTHR 10 RT 120	1.85	8
200	BTHR 10 RT 200	1.82	8
600	BTHR 10 RT 600	1.82	5

Our systems have been tested according to DIN EN 1264.

Levelling panel

Schlüter®-BEKOTEC-ENFGK

The levelling panel Schlüter-BEKOTEC-ENFGK is installed in front of heating circuit distributors to simplify the heating pipe installation in the distributor cabinet. The polystyrene panel is adhered to the studded panel with the supplied double sided adhesive tape (6 m).

Schlüter®-BEKOTEC-ENFGK

levelling panel set for EN 12 FK

Art. No.	€ / Set	P (Set)
EN 12 FGK	29.38	10

Working area: 110 x 70 cm = 0.77 m²

Set includes:

- 1 levelling panel
- 6 m double sided adhesive tape

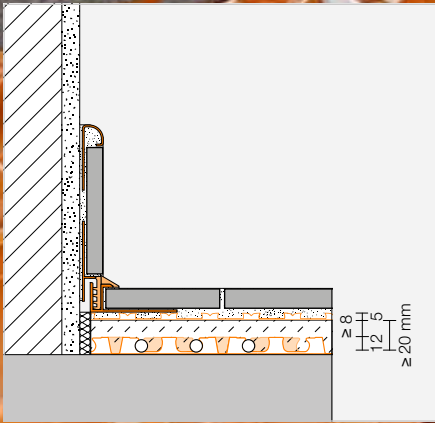

Schlüter®-BEKOTEC-EN-FK-PS

The lightweight type – now in a self-adhesive version too

Technical system details

System height (incl. DITRA)	25 – 32 mm
Studded screed panel height	12 mm
Screed coverage	8 – 15 mm
Pipe diameter	10 x 1.3 mm
Pipe installation spacing	50 100 150 200 250 300 mm
Heating pipe requirements	20 10 6.66 5 4 3.33 m/m ²
Max. heat output (VT 40 °C / RT 20 °C)*	145 120 80 50 40 30 W/m ²
Min. weight per unit area	40 kg/m ²
Min. screed volume	20 l/m ²
Max. traffic load	up to 5 kN/m ²

* VT = supply temperature / RT = room temperature

Technical details on the studded screed panel

Working area	110 x 70 cm = 0.77 m ²
Notes about insulation	not suitable for use over an insulation layer

Note:

The uncoupling mat Schlüter-DITRA must be adhered over the screed prior to the installation of ceramic tiles or natural stone. The mat can be installed as soon as the screed is ready to bear weight (gypsum screeds: < 2 % residual moisture).

Please observe the instructions of our product data sheets 6.1 and 9.7.

Further information can be found in our Technical Manual.

Studded screed panel

Schlüter®-BEKOTEC-EN-FK-PS



Schlüter-BEKOTEC-EN-FK-PS is a studded screed panel made of high impact polystyrene with a self-adhesive backing. The studded panel is installed on suitable, weight bearing substrates after peeling off the release film. The cut back studs hold the heating pipe in a defined pattern (50 mm grid). The BEKOTEC panels are connected by overlapping a row of studs and clicking the panels together. A minimum coverage of 8 mm (max. 15 mm), using a commercial cement or gypsum screed (compressive strength C20–C35 / flexural strength F4 max. F5) and the BEKOTEC-THERM-HR heating pipes make sure that system coverings made of ceramic tile and natural stone remain permanently crack-free. Please refer to our Technical Manual for coverings and installations made of alternative materials.

Schlüter®-BEKOTEC-EN 12 F PS

self-adhesive studded screed panel

Art. No.	€/ m ²	P (Unit)
EN 12 F PS	25.50	20

1 panel (0.77 m²) = smallest delivery unit

Edging strip:

The edging strip BRS 808 KSF must be used with studded screed panels EN 12 F PS (see page 38).

Heating pipe

Schlüter®-BEKOTEC-THERM-HR

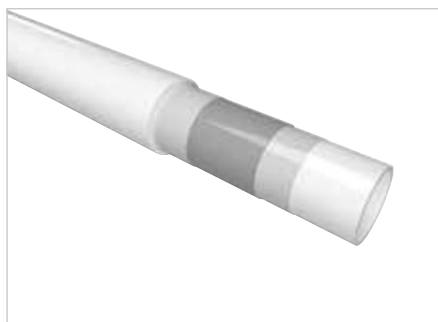

Schlüter-BEKOTEC-THERM-HR is a 5-ply bonded heating pipe made of a high-quality polymer material (PE-RT) with an oxygen diffusion barrier in the centre. The highly flexible heating pipe, which complies with DIN 16833, is optimised for installation in BEKOTEC system panels. Its oxygen tightness is certified according to DIN 4726, and the product is subject to continuous quality monitoring.

Schlüter®-BEKOTEC-THERM-HR

heating pipe 10 x 1.3 mm for EN 12 F PS

L (m)	Art. No.	€/ m	P (Roll)
70	BTHR 10 RT 70	1.85	8
120	BTHR 10 RT 120	1.85	8
200	BTHR 10 RT 200	1.82	8
600	BTHR 10 RT 600	1.82	5

Levelling panel

Schlüter®-BEKOTEC-ENFGK-PS

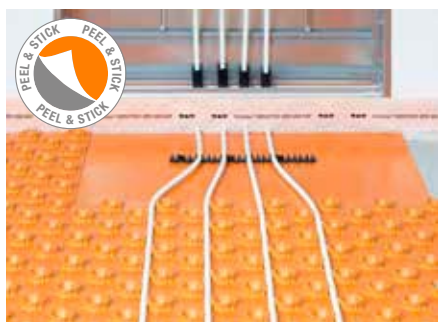

The levelling panel Schlüter-BEKOTEC-ENFGK-PS is installed in front of heating circuit distributors to simplify the heating pipe installation in the distributor cabinet. The panel has a self-adhesive backing covered with a release film.

Schlüter®-BEKOTEC-ENFGK-PS

self-adhesive levelling panel for EN 12 F PS

Art. No.	€/ U.	P (Unit)
EN 12 FG PS	22.00	10

Working area: 110 x 70 cm = 0.77 m²

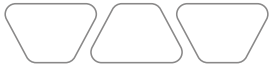

Connection package

All connection components for heating pipes \varnothing 16 mm



Our connection package includes all products required for connecting Schlüter-BEKOTEC-THERM heating circuits to the heating system. In addition to a stainless steel distributor with temperature gauge, it includes clamping rings, angle clips and actuators. Everything you need ready for installation on site in a single, waste-optimised package.

The connection package is suitable for the following systems:

BEKOTEC-EN-FI
BEKOTEC-EN-P/-PF
BEKOTEC-EN-F-PS

Package content



- ✓ **Stainless steel distributor with temperature gauge** (see page 42 for further information)
- ✓ **Clamping rings**
- ✓ **Angle clips**
- ✓ **Clips for studded screed panels**
- ✓ **Actuators (more details from page 51)**

Schlüter®-BEKOTEC connection package

connection components for the EN-FI / EN-P / EN-PF / EN-F-PS systems

Description	Art. No.	€ / Set	P (Set)
for 2 heating circuits, pipe \varnothing 16 mm	BT 2 AS 16	333.01	5
for 3 heating circuits, pipe \varnothing 16 mm	BT 3 AS 16	444.43	5
for 4 heating circuits, pipe \varnothing 16 mm	BT 4 AS 16	565.86	5
for 5 heating circuits, pipe \varnothing 16 mm	BT 5 AS 16	688.54	5
for 6 heating circuits, pipe \varnothing 16 mm	BT 6 AS 16	807.48	5
for 7 heating circuits, pipe \varnothing 16 mm	BT 7 AS 16	928.92	5
for 8 heating circuits, pipe \varnothing 16 mm	BT 8 AS 16	1051.60	5
for 9 heating circuits, pipe \varnothing 16 mm	BT 9 AS 16	1170.54	5
for 10 heating circuits, pipe \varnothing 16 mm	BT 10 AS 16	1292.59	5
for 11 heating circuits, pipe \varnothing 16 mm	BT 11 AS 16	1414.65	5
for 12 heating circuits, pipe \varnothing 16 mm	BT 12 AS 16	1533.59	5

Note:

A ball valve may be necessary for connection to the heating network; please order separately (see page 52).

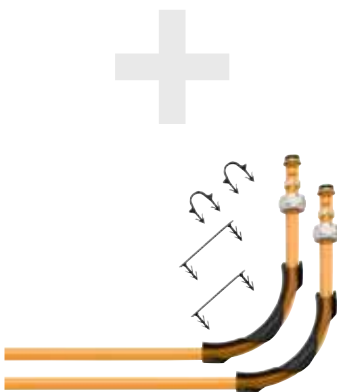

Connection package

All connection components for heating pipes \varnothing 14 mm



Our connection package includes all products required for connecting Schlüter-BEKOTEC-THERM heating circuits to the heating system. In addition to a stainless steel distributor with temperature gauge, it includes clamping rings, angle clips and actuators. Everything you need ready for installation on site in a single, waste-optimised package.

The connection package is suitable for the following systems:

BEKOTEC-EN-FI
BEKOTEC-EN-F/-F-PS

Package content



- ✓ **Stainless steel distributor with temperature gauge (see page 42 for further information)**
- ✓ **Clamping rings**
- ✓ **Angle clips**
- ✓ **Actuators (more details from page 51)**

Schlüter®-BEKOTEC connection package

connection components for the EN-FI / EN-F / EN-F-PS systems

Description	Art. No.	€ / Set	P (Set)
for 2 heating circuits, pipe \varnothing 14 mm	BT 2 AS 14	323.00	5
for 3 heating circuits, pipe \varnothing 14 mm	BT 3 AS 14	444.43	5
for 4 heating circuits, pipe \varnothing 14 mm	BT 4 AS 14	563.36	5
for 5 heating circuits, pipe \varnothing 14 mm	BT 5 AS 14	682.29	5
for 6 heating circuits, pipe \varnothing 14 mm	BT 6 AS 14	801.22	5
for 7 heating circuits, pipe \varnothing 14 mm	BT 7 AS 14	923.90	5
for 8 heating circuits, pipe \varnothing 14 mm	BT 8 AS 14	1045.35	5
for 9 heating circuits, pipe \varnothing 14 mm	BT 9 AS 14	1164.28	5
for 10 heating circuits, pipe \varnothing 14 mm	BT 10 AS 14	1283.21	5
for 11 heating circuits, pipe \varnothing 14 mm	BT 11 AS 14	1402.14	5
for 12 heating circuits, pipe \varnothing 14 mm	BT 12 AS 14	1521.07	5

Note:

A ball valve may be necessary for connection to the heating network; please order separately (see page 52).

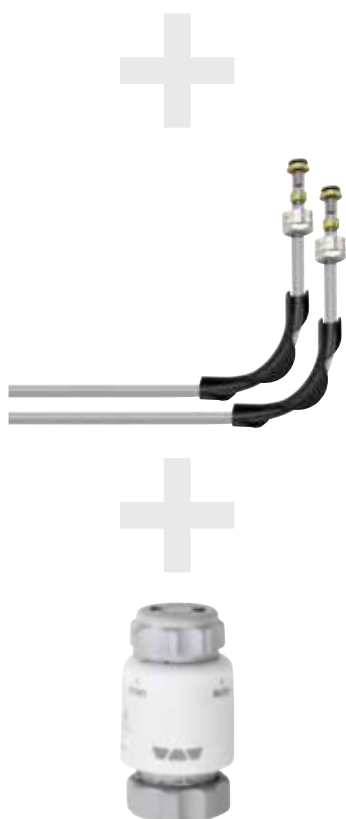



Connection package

All connection components for heating pipes Ø 12 mm



Our connection package includes all products required for connecting Schlüter-BEKOTEC-THERM heating circuits to the heating system. In addition to a stainless steel distributor with temperature gauge, it includes clamping rings, angle clips and actuators. Everything you need ready for installation on site in a single, waste-optimised package.

The connection package is suitable for the following systems:
BEKOTEC-EN-FTS

Package content



- ✓ **Stainless steel distributor with temperature gauge** (see page 42 for further information)
- ✓ **Clamping rings**
- ✓ **Angle clips**
- ✓ **Actuators (more details from page 51)**

Schlüter®-BEKOTEC connection package

connection components for the EN-FTS system

Description	Art. No.	€ / Set	P (Set)
for 2 heating circuits, pipe Ø 12 mm	BT 2 AS 12	325.50	5
for 3 heating circuits, pipe Ø 12 mm	BT 3 AS 12	444.43	5
for 4 heating circuits, pipe Ø 12 mm	BT 4 AS 12	563.36	5
for 5 heating circuits, pipe Ø 12 mm	BT 5 AS 12	682.29	5
for 6 heating circuits, pipe Ø 12 mm	BT 6 AS 12	804.97	5
for 7 heating circuits, pipe Ø 12 mm	BT 7 AS 12	926.42	5
for 8 heating circuits, pipe Ø 12 mm	BT 8 AS 12	1045.35	5
for 9 heating circuits, pipe Ø 12 mm	BT 9 AS 12	1164.28	5
for 10 heating circuits, pipe Ø 12 mm	BT 10 AS 12	1283.21	5
for 11 heating circuits, pipe Ø 12 mm	BT 11 AS 12	1408.40	5
for 12 heating circuits, pipe Ø 12 mm	BT 12 AS 12	1527.32	5

Note:

A ball valve may be necessary for connection to the heating network; please order separately (see page 52).



Connection package

All connection components for heating pipes \varnothing 10 mm



Our connection package includes all products required for connecting Schlüter-BEKOTEC-THERM heating circuits to the heating system. In addition to a stainless steel distributor with temperature gauge, it includes clamping rings, angle clips and actuators. Everything you need ready for installation on site in a single, waste-optimised package.

The connection package is suitable for the following systems:
BEKOTEC-EN-FK/-FK-PS

Package content



- ✓ **Stainless steel distributor with temperature gauge** (see page 42 for further information)
- ✓ **Clamping rings**
- ✓ **Angle clips**
- ✓ **Actuators (more details from page 51)**

Schlüter®-BEKOTEC connection package

connection components for the EN-FK / EN-FK-PS systems

Description	Art. No.	€ / Set	P (Set)
for 2 heating circuits, pipe \varnothing 10 mm	BT 2 AS 10	325.50	5
for 3 heating circuits, pipe \varnothing 10 mm	BT 3 AS 10	444.43	5
for 4 heating circuits, pipe \varnothing 10 mm	BT 4 AS 10	563.36	5
for 5 heating circuits, pipe \varnothing 10 mm	BT 5 AS 10	682.29	5
for 6 heating circuits, pipe \varnothing 10 mm	BT 6 AS 10	807.48	5
for 7 heating circuits, pipe \varnothing 10 mm	BT 7 AS 10	926.42	5
for 8 heating circuits, pipe \varnothing 10 mm	BT 8 AS 10	1045.35	5
for 9 heating circuits, pipe \varnothing 10 mm	BT 9 AS 10	1164.28	5
for 10 heating circuits, pipe \varnothing 10 mm	BT 10 AS 10	1283.21	5
for 11 heating circuits, pipe \varnothing 10 mm	BT 11 AS 10	1408.40	5
for 12 heating circuits, pipe \varnothing 10 mm	BT 12 AS 10	1527.32	5

Note:

A ball valve may be necessary for connection to the heating network; please order separately (see page 52).





Renovation set

All components for Schlüter®-BEKOTEC-EN-F

Our BEKOTEC renovation set includes 13 m² of our EN 23 F system panel, the matching system heating pipe in a diameter of 14 mm (70 m), 2 clamping rings and a return temperature limiter with a white plastic cover.

Set content

- ✓ BEKOTEC EN 23 F system panels (12 units), total 12.96 m²
- ✓ Schlüter system heating pipe Ø 14 mm, 70 m
- ✓ Return temperature limiter
- ✓ Clamping rings

Schlüter®-BEKOTEC renovation set

system components for EN-F

Art. No.	€ / Set	P (Set)
BT EN 23 F S1	569.62	5

Note:

A connector fitting may be necessary for connection to the heating network; please order separately (see page 41).

The renovation set does not include edge insulation strips. Please order them separately depending on the screed to be used in the project (see page 38).



Renovation set

All components for Schlüter®-BEKOTEC-EN-FK

Our BEKOTEC renovation set includes 8 m² of our EN 12 FK system panel, the matching system heating pipe in a diameter of 10 mm (70 m), 2 clamping rings and a return temperature limiter with a white plastic cover.

Set content

- ✓ BEKOTEC EN 12 FK system panels (10 units), total 7.7 m²
- ✓ Schlüter system heating pipe Ø 10 mm, 70 m
- ✓ Return temperature limiter
- ✓ Clamping rings



Schlüter®-BEKOTEC renovation set

system components for EN-FK

Art. No.	€ / Set	P (Set)
BT EN 12 FK S1	522.98	5

Note:

A connector fitting may be necessary for connection to the heating network; please order separately (see page 41).

The renovation set does not include edge insulation strips. Please order them separately depending on the screed to be used in the project (see page 38).

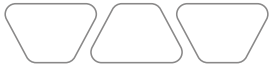

Accessories

Everything you need for your floor heating system

Edging strip

Schlüter®-BEKOTEC-BRS



Schlüter-BEKOTEC-BRS is an edging strip of closed cell polyethylene foam with an integrated foil leg. The edging strip is installed along walls or fixed room components. The foil leg is installed beneath the Schlüter-BEKOTEC panels or the PE foil cover and is suitable for conventional cement screeds. The finishing strip Schlüter-BEKOTEC-BRSK is equipped with an additional adhesive strip for attachment to the wall.

Schlüter®-BEKOTEC-BRS

edging strip (BRS 810) edging strip, self adhesive (BRSK 810)

Art. No.	€ / m	P (Roll)
BRS 810	1.09	10
BRSK 810	1.44	10

Dimensions: 8 mm x 100 mm x 50 m

Suitable studded screed panels:

EN 23 FI 30
EN 2520 P

Schlüter®-BEKOTEC-BRS/KF



Schlüter-BEKOTEC-BRS/KF is an edge strip of closed cell polyethylene foam with an adhesive leg and an adhesive backing for wall attachment. When the BEKOTEC studded panel is laid on the PE adhesive, the resulting connection prevents flowing screeds from running underneath the assembly during installation.

Schlüter®-BEKOTEC-BRS/KF

edging strip with integrated adhesive leg

Art. No.	€ / m	P (Roll)
BRS 808 KF	2.32	10

Dimensions: 8 mm x 80 mm x 25 m

Suitable studded screed panels:

EN 23 FI 30
EN 2520 P
EN 1520 PF

Schlüter®-BEKOTEC-BRS/KSF



Schlüter-BEKOTEC-BRS/KSF is an edging strip of closed cell polyethylene foam with an integrated foil leg that features an adhesive strip on both sides for attachment. The edging strip is pressed toward the wall by the adhesion on the substrate and the pre-tensioning of the integrated foil leg. When the studded panel BEKOTEC is laid on top of the adhesive strip, flowing screed can no longer flow underneath the panel.

Schlüter®-BEKOTEC-BRS/KSF

edging strip with integrated adhesive leg

Art. No.	€ / m	P (Roll)
BRS 808 KSF	3.14	5

Dimensions: 8 mm x 80 mm x 25 m

Suitable studded screed panels:

EN 23 FI 30
EN 2520 P
EN 1520 PF
EN 23 F
EN 23 F PS
EN 18 FTS 5
EN 12 FK
EN 12 F PS

Impact sound insulation

Schlüter®-BEKOTEC-BTS



Schlüter-BEKOTEC-BTS is a 5 mm insulation layer of closed cell polyethylene foam for installation below the studded screed panels Schlüter-BEKOTEC-EN-P, -EN-PF and -EN 23 F. The use of BEKOTEC-BTS results in a significant improvement of sound insulation. The material can be used if the required construction height is not sufficient for a thick insulation layer of polystyrene or mineral fibre. The maximum floor load must be limited to 2 kN/m².

Schlüter®-BEKOTEC-BTS

PE impact sound insulation

Art. No.	€ / m ²	P (Roll)
BTS 510	5.42	5

Dimensions: 5 mm x 1 m x 50 m

Expansion joint profile

Schlüter®-DILEX-DFP

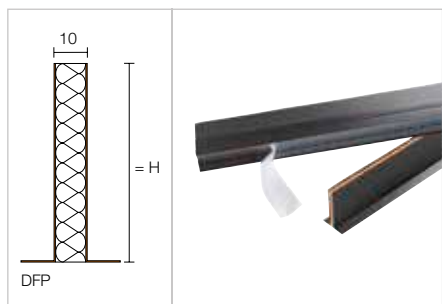

Schlüter-DILEX-DFP is a movement joint profile to be installed at door areas or used to divide screed areas. Please note the instructions in our Technical Manual and data sheet 9.1 on flexible movement joints and expansion joints.

Schlüter®-DILEX-DFP

flexible movement joint

H (mm)	L = 1.00 m Art. No.	€ / m	P (Unit)
60	DFP 6/100	13.30	20
80	DFP 8/100	15.63	20
100	DFP 10/100	18.21	20
	L = 2.50 m		KV (Unit)
100	DFP 10/250	17.59	40

Dispensing unit

Schlüter®-BEKOTEC-THERM-HERO



Schlüter-BEKOTEC-THERM-HERO is a dispensing unit for all BEKOTEC-THERM heating pipes. It is universally suitable for all lengths and diameters. In addition, all dispensing units are shipped in a user-friendly carrying bag for safe and convenient transport.

Schlüter®-BEKOTEC-THERM-HERO

heating pipe dispenser

Art. No.	€ / U.	P (Unit)
BTZ HR A	688.54	5

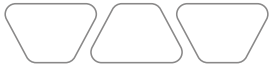

Attachment

Schlüter®-BEKOTEC-ZDK



Schlüter-BEKOTEC-ZDK is a double sided adhesive tape for adhering the studded panel to the substrate or the levelling panels.

Schlüter®-BEKOTEC-ZDK

double sided adhesive tape

Art. No.	€ / U.	P (Unit)
BT ZDK 66	78.93	10

Schlüter®-BEKOTEC-ZRKL



Schlüter-BEKOTEC-ZRKL is a pipe clamping strip for securing the pipes on the levelling panel. The self-adhesive clamping strips are simply adhered to the levelling panels in front of the heating circuit distributor.

Schlüter®-BEKOTEC-ZRKL

pipe clamping strip for heating pipes Ø 14–16 mm

L (cm)	Art. No.	€ / U.	P (Unit)
20	BT ZRKL	5.97	10

Number of pipe spaces: 4 units

Schlüter®-BEKOTEC-ZRKL

pipe clamping strip for heating pipes Ø 10–12 mm

L (cm)	Art. No.	€ / U.	P (Unit)
80	BT ZRKL 1012	5.81	10

Number of pipe spaces: 32 units

Schlüter®-BEKOTEC-THERM-RH



Schlüter-BEKOTEC-THERM-RH are plastic clips with barbs for anchoring 16 mm heating pipes into the BEKOTEC studded panels in critical areas. Size 75 is suitable for multiple heating pipes, while size 17 only accommodates a single pipe.

Note:

Heating pipe clips are suitable for use with the studded panels EN-P and EN-PF only.

Schlüter®-BEKOTEC-THERM-RH

heating pipe clips for 16 mm heating pipes

Art. No.	€ / Package	P (Package)
BTZ RH 75/100	33.86	10
BTZ RH 17/100	17.75	10

Package = 100 units

Schlüter®-BEKOTEC-THERM-ZW



Schlüter-BEKOTEC-THERM-ZW is an angle clip of synthetic material for defined 90° bends of the heating pipes in diameters 10, 12, 14 or 16 mm in the distributor cabinet. The angle clip is easy to attach to the heating pipes from the side. The use of the clips is recommended to facilitate installation in the distributor cabinet if the thickness of the screed layer is relatively low.

Schlüter®-BEKOTEC-THERM-ZW

angle clip

Ø mm	Art. No.	€ / U.	P (Unit)
10-12	BT ZW 1014	2.77	50
14-16	BT ZW 1418	2.84	50

Note:

2 units required per heating circuit (hot and cold leg).

Clamping ring

Schlüter®-BEKOTEC-THERM-KV



Schlüter-BEKOTEC-THERM-KV is a clamping ring for the hot and cold leg made of nickel plated brass. It connects the Schlüter heating pipes (diameter 10, 12, 14, 16 mm) with the Schlüter heating circuit distributor.

Schlüter®-BEKOTEC-THERM-KV

clamp connection

Ø mm	Art. No.	€ / Set	P (Set)
10	BTZ2 KV 10	11.34	10
12	BTZ2 KV 12	11.34	10
14	BTZ2 KV 14	10.57	10
16	BTZ2 KV 16	10.57	10

Set = 2 units

Schlüter®-BEKOTEC-THERM-KU



Schlüter-BEKOTEC-THERM-KU is a double clamping ring made of nickel plated brass for the connection of Schlüter heating pipes, diameter 10, 12, 14 or 16 mm.

Schlüter®-BEKOTEC-THERM-KU

connection coupling

Ø mm	Art. No.	€ / U.	P (Unit)
10	BTZ KU 10 S	19.77	10
12	BTZ KU 12	18.49	10
14	BTZ KU 14	16.44	10
16	BTZ KU 16	16.44	10

Connection

Schlüter®-BEKOTEC-THERM-AN



Schlüter-BEKOTEC-THERM-AN is a connector fitting made of nickel plated brass. One side has a self sealing 1/2" (DN 15) external thread, while the other side features a 3/4" (DN 20) compression fitting for connecting the 14 mm or 16 mm Schlüter heating pipe – fits all Euro cone fittings.

Schlüter®-BEKOTEC-THERM-AN

connector fitting

Ø mm	Art. No.	€ / Set	P (Set)
14	BTZ2 AN 14	17.07	10
16	BTZ2 AN 16	17.07	10

Set = 2 units

Note:

10 or 12 mm pipes can be connected with the clamp connection BTZ2 KV 10/12 (order separately).

Schlüter®-BEKOTEC-THERM-AW



Schlüter-BEKOTEC-THERM-AW is an angled connection fitting made of nickel plated brass that can be rotated. One side has a self sealing 1/2" (DN 15) external thread, while the other side features a 3/4" (DN 20) compression fitting for connecting the 14 mm or 16 mm Schlüter heating pipe.

Schlüter®-BEKOTEC-THERM-AW

angled connector fitting

Ø mm	Art. No.	€ / Set	P (Set)
14	BTZ2 AW 14	32.97	10
16	BTZ2 AW 16	32.97	10

Set = 2 units

Note:

10 or 12 mm pipes can be connected with the clamp connection BTZ2 KV 10/12 (order separately).



Heating circuit distributor stainless steel

Schlüter®-BEKOTEC-THERM-HVT/DE



Schlüter-BEKOTEC-THERM-HVT/DE is a heating circuit distributor DN 25 of stainless steel with hot leg and cold leg bars, outside diameter 35 mm.

The installation uses 2 distributor manifold brackets with sound insulation inserts, matching the Schlüter distributor cabinet, as well as a wall mounting set. Both are included in the scope of supply.

The scope of supply includes the following pre-assembled components:

- Hot leg flow meter with transparent scale, adjustable from 0.5 to 3.0 l/min. for regulating flow quantities
- Integrated temperature gauge, can be mounted on both sides
- Thermostat valves, adjustable manually for every heating circuit, matching the electronically controlled Schlüter actuators
- One manual vent, nickel plated brass for hot and cold leg, respectively
- Filling and evacuation valve, 1/2" (DN 15), rotatable, nickel plated brass
- End plug 3/4" (DN 20), nickel plated brass
- Distributor connection, with 1" flat gasket male fitting (DN 25)
- Heating circuit terminals, spaced 50 mm apart, consisting of connector nozzle 3/4" (DN 20) AG with cone, matching Schlüter clamp connections

Schlüter®-BEKOTEC-THERM-HVT/DE

heating circuit distributor

Number of heating circuits	Length A [mm]	Art. No.	€ / Set	P (Set)
2	215	BTHVT 2 DE	216.17	5
3	245	BTHVT 3 DE	278.95	5
4	295	BTHVT 4 DE	341.85	5
5	347	BTHVT 5 DE	404.63	5
6	397	BTHVT 6 DE	467.48	5
7	447	BTHVT 7 DE	530.27	5
8	497	BTHVT 8 DE	593.09	5
9	547	BTHVT 9 DE	655.94	5
10	597	BTHVT 10 DE	718.77	5
11	647	BTHVT 11 DE	781.60	5
12	697	BTHVT 12 DE	844.40	5

Schlüter®-BEKOTEC-THERM-HVE



Schlüter-BEKOTEC-THERM-HVE is a heating circuit distributor manifold expansion for the subsequent expansion of the Schlüter heating circuit distributor of stainless steel.

The scope of supply includes the following pre-assembled components:

- Hot leg flow meter with transparent scale, adjustable from 0.5 to 3.0 l/min. for regulating flow quantities
- Thermostat valve, adjustable manually, matching the electronically controlled Schlüter actuators
- Heating circuit terminal with connector nozzle 3/4" (DN 20) AG with cone, matching the Schlüter clamp connections

Schlüter®-BEKOTEC-THERM-HVE

heating circuit distributor expansion

Art. No.	€ / Set	P (Set)
BT HVE 1 DE	127.93	5

Note:

The connection to the BEKOTEC-THERM heating pipes requires a set of clamp connections BTZ 2 KV... as well as two angle clips BT ZW...

Heating circuit distributor plastic

Schlüter®-BEKOTEC-THERM-HVP

Schlüter-BEKOTEC-THERM-HVP is a heating circuit distributor made of fibreglass-reinforced plastic. It can be flexibly assembled with up to 12 heating circuit modules and end modules. The modular heating circuit terminals (spacing: 50 mm) can be rotated by 180°, are suitable for connection on both sides, and are secured by the integrated attachment elements.

Ball valve sets DN 25 or DN 20 and installation bracket sets are available separately for installation in the distributor cabinet or on plastered walls. Please refer to the Technical Manual for detailed information about installed dimensions and sample configurations.

Heating circuit module

Schlüter®-BEKOTEC-THERM-HVP

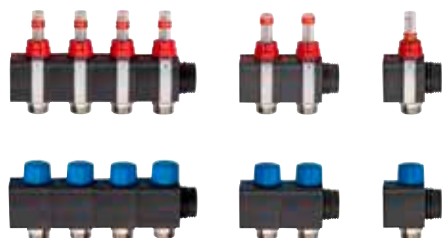

Schlüter-BEKOTEC-THERM-HVP is a heating circuit module set composed of hot leg and cold leg modules.

The hot leg comprises a flow meter with transparent scale, adjustable from 0.5–5.0 l/min, while the cold leg consists of an integrated thermostat valve with cover cap, matching the electronically controlled Schlüter actuators.

Schlüter®-BEKOTEC-THERM-HVP

hot leg and cold leg modules for plastic distributor

Connections	Art. No.	€ / Set	P (Set)
1	BT HVT 1 DK	53.83	5
2	BT HVT 2 DK	107.67	5
4	BT HVT 4 DK	215.32	5

Note:

Set, comprising both hot and cold leg.

End module set

Schlüter®-BEKOTEC-THERM-HVP set



The Schlüter-BEKOTEC-THERM-HVP set comprises 2 end modules with a 1" flat gasket male fitting, a filling and evacuation valve 1/2" (rotatable) and a temperature gauge.

Schlüter®-BEKOTEC-THERM-HVP set

connection set for plastic distributor

Art. No.	€ / Set	P (Set)
BT HVT ASK	118.74	5

Note:

Set, comprising both hot and cold leg.

Installation bracket

Schlüter®-BEKOTEC-THERM-HK

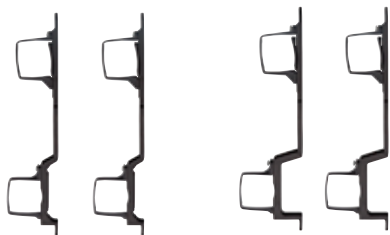

Set flat

Set high

Schlüter-BEKOTEC-THERM-HK is an installation bracket set for installation in the distributor cabinet or on the wall.

Schlüter®-BEKOTEC-THERM-HK

installation bracket

H (mm)	Art. No.	€ / Set	P (Set)
80	BT HVT KF	19.03	5
98	BT HVT KH	19.93	5

Set = 2 units

Note:

The tall installation bracket set BT HVT KH must be used with the BEKOTEC-THERM-EAHB actuator.



Sample configurations:



4 heating circuits

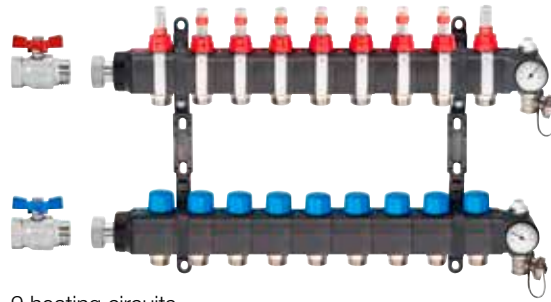

9 heating circuits

Ball valve	HVP (end module set)	HVP (hot leg and cold leg modules)		HK (installation bracket)		Actuator
Set	Set	9 heating circuits (4 + 2 + 2 + 1)		Set flat	Set high	per heating circuit
		4 heating circuits	5 heating circuits			
						<p>4 or 9</p>

Heating circuit distributor connection set

Schlüter®-BEKOTEC-THERM-HV/AS

Schlüter-BEKOTEC-THERM-HV/AS are accessory sets for connecting the heating circuits to Schlüter heating circuit distributors (stainless steel or plastic), for heating pipes with Ø 10, 12, 14 or 16 mm.

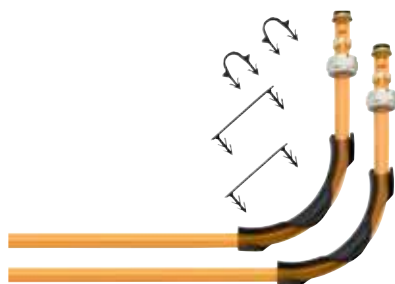

Connection set components for heating pipe Ø 16 mm



Connection set components for heating pipe Ø 14 mm



Connection set components for heating pipe Ø 12 or 10 mm

Schlüter®-BEKOTEC-THERM-HV/AS									
Number of heating circuits	distributor connection set Ø 16 mm systems FI / P / PF / F-PS		distributor connection set Ø 14 mm systems FI / F / F-PS		distributor connection set Ø 12 mm system FTS		distributor connection set Ø 10 mm systems FK / FK-PS		P (Set)
	Art. No.	€ / Set	Art. No.	€ / Set	Art. No.	€ / Set	Art. No.	€ / Set	
2	BTHV 2 AS	36.20	BTHV 2 AS 14	34.10	BTHV 2 AS 12	35.01	BTHV 2 AS 10	35.01	5
3	BTHV 3 AS	54.34	BTHV 3 AS 14	51.10	BTHV 3 AS 12	51.53	BTHV 3 AS 10	51.53	5
4	BTHV 4 AS	72.43	BTHV 4 AS 14	68.11	BTHV 4 AS 12	69.12	BTHV 4 AS 10	69.12	5
5	BTHV 5 AS	90.54	BTHV 5 AS 14	85.12	BTHV 5 AS 12	85.91	BTHV 5 AS 10	85.91	5
6	BTHV 6 AS	108.69	BTHV 6 AS 14	102.13	BTHV 6 AS 12	103.98	BTHV 6 AS 10	103.98	5
7	BTHV 7 AS	126.77	BTHV 7 AS 14	119.15	BTHV 7 AS 12	121.31	BTHV 7 AS 10	121.31	5
8	BTHV 8 AS	144.89	BTHV 8 AS 14	136.14	BTHV 8 AS 12	138.87	BTHV 8 AS 10	138.87	5
9	BTHV 9 AS	162.95	BTHV 9 AS 14	153.17	BTHV 9 AS 12	155.66	BTHV 9 AS 10	155.66	5
10	BTHV 10 AS	181.04	BTHV 10 AS 14	170.20	BTHV 10 AS 12	173.70	BTHV 10 AS 10	173.70	5
11	BTHV 11 AS	199.16	BTHV 11 AS 14	187.20	BTHV 11 AS 12	190.96	BTHV 11 AS 10	190.96	5
12	BTHV 12 AS	217.24	BTHV 12 AS 14	204.22	BTHV 12 AS 12	207.82	BTHV 12 AS 10	207.82	5

Connection set components	Ø 16 x 2 mm	Example: BTHV 5 AS for 5 component heating circuit distributor	Ø 14 x 2 mm	Example: BTHV 7 AS 14 for 7 component heating circuit distributor
Clamp connections	2 units per heating circuit	10 units	2 units per heating circuit	14 units
Angle clips	2 units per heating circuit	10 units	2 units per heating circuit	14 units
Heating pipe clamp RH 17	2 units per heating circuit	10 units	–	–
Heating pipe clamp RH 75	2 units per heating circuit	10 units	–	–

Connection set components	Ø 12 x 1.5 mm	Example: BTHV 5 AS 12 for 5 component heating circuit distributor	Ø 10 x 1.3 mm	Example: BTHV 7 AS 10 for 7 component heating circuit distributor
Clamp connections	2 units per heating circuit	10 units	2 units per heating circuit	14 units
Angle clips	2 units per heating circuit	10 units	2 units per heating circuit	14 units

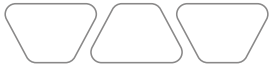

Distributor cabinet installation

Schlüter®-BEKOTEC-THERM-VSE



Schlüter-BEKOTEC-THERM-VSE is a distributor cabinet for concealed mounting to house the Schlüter heating circuit distributor manifold and the matching control components. The concealed cabinet consists of fully galvanised steel with perforations in the lateral walls for inserting the connector pipes. The front side (door and frame) is powder coated.

Set includes:

- Two lateral installation pedestals, height adjustable from 0 to 90 mm
- Powder coated screed panel, height adjustable and removable
- Heating pipe rail
- Two adjustable attachment rails for Schlüter heating circuit distributors and an additional installation rail for simple plug in installation of the Schlüter connection modules

Note:

The powder coated frame and door come in separate packaging and can be retrofitted with 4 tuck flaps with wing screws, with variable attachment options for in wall openings of 110 to 150 mm. The door can be closed with a rotating latch. A lock with the corresponding keys is available as a special accessory (art. no.: BT ZS). Colour: VW = Traffic white (RAL 9016)

Schlüter®-BEKOTEC-THERM-VSE

distributor cabinet for concealed mounting of stainless steel/plastic distributors

Art. No.	Outside dimensions (B x H x T = mm)	Maximum heating circuits without PW*	Maximum heating circuits with PW* vertical	Maximum heating circuits with PW* horizontal	Maximum heating circuits with incl. FRS**	€ / U.	P (Unit)
BT VSE 4 VW	490 x 705 x 110	4	3	–	2	199.86	5
BT VSE 5 VW	575 x 705 x 110	6	5	3	3*	220.30	5
BT VSE 8 VW	725 x 705 x 110	9	8	6	5	254.97	5
BT VSE 11 VW	875 x 705 x 110	12	11	9	8	286.66	5
BT VSE 12 VW	1025 x 705 x 110	12	12	12	12	322.12	5
BT ZS	Distributor cabinet lock with 2 standard keys					23.11	5

* PW = blank set for calorimeter ** FRS = fixed-value control station

Note:

When using the plastic heating circuit distributor and the fixed-value control station, the distributor cabinet in this configuration (*) can only accommodate 2 heating circuit terminals.

On-wall distributor cabinet

Schlüter®-BEKOTEC-THERM-VSV



Schlüter-BEKOTEC-THERM-VSV is a distributor cabinet for surface mounting to house the Schlüter heating circuit distributor manifold and the matching control components. The distributor cabinet consists of galvanised steel with powder coating on the inside and outside.

Set includes:

- Two lateral installation pedestals, height adjustable from 0 to 90 mm
- Screed panel, removable
- Heating pipe rail
- Two adjustable attachment rails for Schlüter heating circuit distributors and an additional installation rail for simple plug in installation of the Schlüter connection modules

Note:

Cabinet depth: 125 mm. The door can be closed with a rotating latch.

A lock with the corresponding keys is available as a special accessory (art. no.: BT ZS). Colour: VW = Traffic white (RAL 9016)

Schlüter®-BEKOTEC-THERM-VSV

distributor cabinet for on-wall mounting of stainless steel/plastic distributors

Art. No.	Outside dimensions (B x H x T = mm)	Maximum heating circuits without PW*	Maximum heating circuits with PW* vertical	Maximum heating circuits with PW* horizontal	Maximum heating circuits with incl. FRS**	€ / U.	P (Unit)
BT VSV 4 VW	496 x 620 x 125	4	3	–	2	270.03	5
BT VSV 5 VW	582 x 620 x 125	5	4	2	3	287.45	5
BT VSV 8 VW	732 x 620 x 125	8	7	5	5	311.44	5
BT VSV 11 VW	882 x 620 x 125	11	10	8	8	333.27	5
BT VSV 12 VW	1032 x 620 x 125	12	12	11	12	379.91	5
BT ZS	Distributor cabinet lock with 2 standard keys					23.11	5

* PW = blank set for calorimeter

** FRS = fixed-value control station

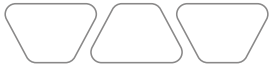

Thermostat

Schlüter®-BEKOTEC-THERM-ER/WL



Schlüter-BEKOTEC-THERM-ER/WL is a remote-controlled thermostat for heating/cooling. The setpoint can be set from 8 to 30 °C (with restrictions if necessary) and is wirelessly transmitted to the connection module EAR 2/6 WL. The EET timer unit manages the temperature reduction. The energy supply consists of an integrated solar cell, or alternatively with a supplied button cell.



Schlüter®-BEKOTEC-THERM-ER/WL

room sensor, wireless

Art. No.	€ / U.	P (Unit)
BT ER WL/BW	216.07	10

Dimensions: 78 x 82.5 x 12.5 mm
Colour: BW = Brilliant white

Schlüter®-BEKOTEC-THERM-ER



Schlüter-BEKOTEC-THERM-ER is a wired thermostat for heating/cooling. The setpoint can be set from 8 to 30 °C (with restrictions if necessary) and is transmitted to the connection module EAR 2/6 with a cable (DC 5 V, SELV). The "Control" base model provides the voltage. The operating state "heating/cooling" is displayed by the "red/blue" colour change in an LED.



Schlüter®-BEKOTEC-THERM-ER

room sensor, wired

Input voltage	Art. No.	€ / U.	P (Unit)
5 V, DC	BT ER/BW	56.66	10

Dimensions: 78 x 78 x 12.5 mm
Colour: BW = Brilliant white

Note:

Only cables with maximum wire cross-sections of 0.8 mm² may be connected to the room sensors BEKOTEC-THERM-ER and the connection modules for BEKOTEC-THERM-EAR.

Cable recommendation:

BTZK 4A 100M, J-Y (St) Y 2 x 2 x 0.6 mm (red, black, white, yellow)

Connection cable

Schlüter®-BEKOTEC-THERM-ZK



Schlüter-BEKOTEC-THERM-ZK is a cable to connect the room sensors BEKOTEC-THERM-ER with the connection modules BT EAR 2 or BT EAR 6.

Schlüter®-BEKOTEC-THERM-ZK

connection cable

L (m)	Art. No.	€ / U.	P (Unit)
100	BTZK 4A 100M	65.21	10

Note:

Only cables with maximum wire cross-sections of 0.8 mm² may be connected to the room sensors BEKOTEC-THERM-ER and the connection modules for BEKOTEC-THERM-EAR.

Base module for room control

Schlüter®-BEKOTEC-THERM-EBC



Schlüter-BEKOTEC-THERM-EBC is the “Control” base module for operating wired and wireless thermostats.

Mixed installations of wired and wireless thermostats are possible.

The base module supplies the wired room sensors with 5 V DC safety extra-low voltage (SELV) via the corresponding connection modules and controls the connected actuators with 230 V AC. The operating state as well as the voltage supply of the input/output is clearly indicated by LEDs.

Schlüter®-BEKOTEC-THERM-EBC

“Control” base module

Input voltage	Art. No.	€ / U.	P (Unit)
230 V, AC	BT EBC	178.52	5

Dimensions: 122 x 92 x 45 mm

Additional functions of the “Control” base module:

- Slot for optional timer unit
- Pump circuit (relay) “Heating”
- Pump circuit (relay) “Cooling”
- Cascade output for connecting the heating/cooling output to additional base modules
- Input for “heating/cooling” switch

Timer

Schlüter®-BEKOTEC-THERM-EET



Schlüter-BEKOTEC-THERM-EET is a timer unit for time-controlled temperature reduction. It can be removed and re-inserted into the “Control” base module to program a time-controlled temperature reduction. A temperature reduction of 4 °C is then effected in the timed periods.

Due to the responsiveness of the BEKOTEC-THERM ceramic thermal comfort floor, the timer unit meets the requirements for quickly controllable systems.

Schlüter®-BEKOTEC-THERM-EET

timer unit

Art. No.	€ / U.	P (Unit)
BT EET	217.37	5

Dimensions: 37 x 92 x 28 mm

Functions:

- Time recording/programming: date, time, weekdays
- Time recording/programming of temperature reduction
- Setting the deferred pump shut-down
- Setting the valve and pump protection function



Connection module wired room control

Schlüter®-BEKOTEC-THERM-EAR

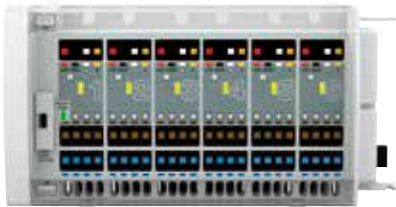

BT EAR 6



BT EAR 2

Schlüter-BEKOTEC-THERM-EAR are modules for connecting 2 or 6 BT ER wired room sensors.

The connection modules BT EAR 2 for 2 or BT EAR 6 for 6 room sensors can be combined by simply plugging them together in order to adjust the number of rooms/heating circuits to be regulated or to adjust and expand the actuators to be assigned. Each channel of the connection module can be assigned to 4 actuators. A combination with the wireless connection modules Schlüter-BEKOTEC-THERM-EAR/WL (wireless) is possible.

The "Control" base model BEKOTEC-THERM-EBC provides the 5 V DC supply voltage (SELV) for the room sensors and 230 V voltage for the actuators.

The operating state as well as the voltage supply of the input/output is clearly indicated by LEDs.

Schlüter®-BEKOTEC-THERM-EAR

connection module for wired room sensors

Input voltage	Art. No.	€ / U.	P (Unit)
230 V, AC	BT EAR 2	131.08	5
230 V, AC	BT EAR 6	198.93	5

Dimensions: 73 x 92 x 45 mm (BT EAR 2)
Dimensions: 162 x 92 x 45 mm (BT EAR 6)

Note:

Only cables with maximum wire cross-sections of 0.8 mm² may be connected to the room sensors BEKOTEC-THERM-ER and the connection modules for BEKOTEC-THERM-EAR.

Cable recommendation:

BTZK 4A 100M, J-Y (St) Y 2 x 2 x 0.6 mm (red, black, white, yellow)



Connection module wireless room control

Schlüter®-BEKOTEC-THERM-EAR/WL



BT EAR 6 WL



BT EAR 2 WL

Schlüter-BEKOTEC-THERM-EAR/WL are modules for connecting 2 or 6 BT ER WL wireless room sensors.

The connection modules BT EAR 2 WL for 2 or BT EAR 6 WL for 6 room sensors can be combined by simply plugging them together in order to adjust the number of rooms/heating circuits to be regulated or to adjust and expand the actuators to be assigned. Each channel of the connection module can be assigned to 4 actuators. A combination with the wired connection modules BEKOTEC-THERM-EAR is possible.

The "Control" base model BEKOTEC-THERM-EBC provides the 230 V voltage for the actuators.

The operating state as well as the voltage supply of the input/output is clearly indicated by LEDs.

Schlüter®-BEKOTEC-THERM-EAR/WL

connection module for wireless room sensors

Input voltage	Art. No.	€ / U.	P (Unit)
230 V, AC	BT EAR 2 WL	375.47	5
230 V, AC	BT EAR 6 WL	526.98	5

Dimensions: 73 x 92 x 45 mm (BT EAR 2 WL)
Dimensions: 162 x 92 x 45 mm (BT EAR 6 WL)

Schlüter®-BEKOTEC-THERM

Even greater efficiency with adaptive hydronic balancing

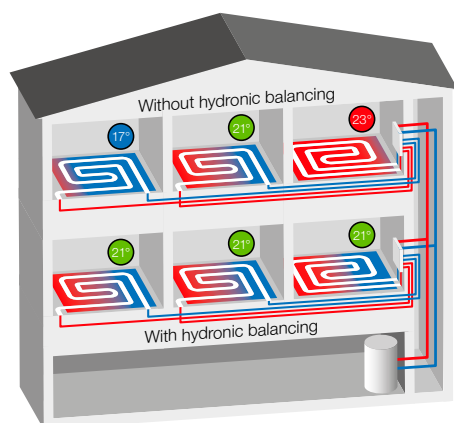

Hydronic balancing drives the energy efficiency of heating and cooling systems. Since every heating circuit receives exactly the right supply volume, the heating system is especially responsive and energy efficient. Intelligent adaptive balancing can optimise the heat distribution even further than static adjustment. It offers the following advantages:

- ✓ **Continuous adjustment to fluctuating operating conditions**
- ✓ **Optimised cold leg temperatures**
- ✓ **No set point calculation for individual heating circuits**
- ✓ **Self-learning ability**
- ✓ **Simple to install**

Actuator for hydronic balancing

Schlüter®-BEKOTEC-THERM-EAHB



Schlüter-BEKOTEC-THERM-EAHB is an actuator for adaptive hydronic balancing with a connector for Schlüter heating circuit distributors with an M30 x 1.5 connection thread. An integrated artificial intelligence component optimises the spread between the measured temperatures and continuously adjusts it to variable situations based on stroke motion. The two temperature sensors are clipped onto the hot leg and cold leg pipe of the respective heating or cooling circuit. The self-learning function continuously optimises the drive response. The power is supplied by the 230 V connector of the Schlüter terminal strip. The connector cable is 1 m long.

Schlüter®-BEKOTEC-THERM-EAHB

actuator

Input voltage	Art. No.	€ / U.	P (Unit)
230 V	BT EAHB 230	100.96	5

Dimensions: 53.1 x 47 x 74.2 mm

Actuator

Schlüter®-BEKOTEC-THERM-ESA



Schlüter-BEKOTEC-THERM-ESA is an actuator for operation with 230 Volt to control the flow of the cold leg valves. It is mounted on the valves of the Schlüter heating circuit distributor cold leg with screws (M30 x 1.5), design according to IP54 (splash water protection).

The valve is supplied in open condition (first-open function) and is manually adjustable in operation (re-open function); the valve is normally closed. The connector cable is 1 m long.

Schlüter®-BEKOTEC-THERM-ESA

actuator

Input voltage	Art. No.	€ / U.	P (Unit)
230 V	BT ESA 230 V2	49.45	5

Dimensions: Ø 40 mm, 75 mm (height)



Locking module

Schlüter®-BEKOTEC-THERM-KH

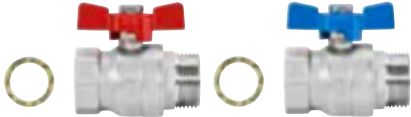

Schlüter-BEKOTEC-THERM-KH is a ball valve set for the hot and cold leg, made of nickel plated brass, with 1" outside threading on one side (DN 25) for flat gasket connection to Schlüter heating circuit distributors and a connection pipe with 3/4" (DN 20) or 1" (DN 25) inside threading.

Schlüter®-BEKOTEC-THERM-KH

ball valve

DN (mm)	Art. No.	€ / Set	P (Set)
20	BTZ2 KH 20	33.21	10
25	BTZ2 KH 25	48.35	10

Set = 2 units

Fixed-value control station

Schlüter®-BEKOTEC-THERM-FRS

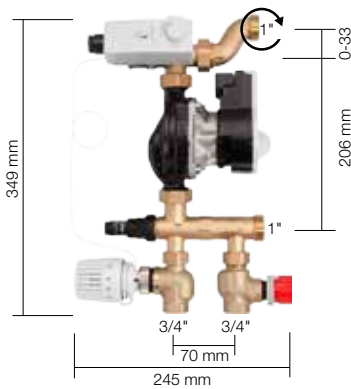

Schlüter-BEKOTEC-THERM-FRS is a fixed-value control station for setting the supply temperature. It enables the installation of a heating circuit distributor (stainless steel or plastic) with 1 to 12 heating circuits. They can be installed in the distributor cabinets VSE/VSV. The fixed-value control supplies the BEKOTEC-THERM ceramic thermal-comfort floor with the required low supply temperatures.

The integrated and pre-assembled set includes:

- High-efficiency pump with pre-wired safety temperature limiter (STB)
- Thermostat valve (DN 20) 3/4" IG on the connection side, with adjustable thermostat head and immersion sensor (20–55 °C)
- Adjustable control valve for setting the primary circuit (DN 20), 3/4" IG on the connection side
- Adjustable bypass for setting the secondary circuit
- Separate attachment for mounting

Schlüter®-BEKOTEC-THERM-FRS

fixed-value control station

Art. No.	€ / Set	P (Set)
BT FRS	1037.83	5

Note:

Prior to installation, a qualified expert should inspect the control technology and hydronic installations. A supply pump (primary pump) must be installed. The installation and assembly instructions of the manufacturer must be observed.

We recommend the use of our "Control" base module.

The integrated pump control switches off the pump of the fixed-value supply temperature control when all actuators at the heating circuit distributor are closed. This variation ensures the energy-efficient operation of the fixed-value control station.

Heating zones valve

Schlüter®-BEKOTEC-THERM-ZV



Schlüter-BEKOTEC-THERM-ZV is a heating zone valve that adjusts all heating circuits connected to the heating circuit distributor. The heating zone valve can be controlled by a Schlüter actuator. The operation is controlled via the BEKOTEC control or a DITRA-HEAT-E thermostat. Connection/material: threaded connection/valve 1" (DN 25) of nickel plated brass.

Schlüter®-BEKOTEC-THERM-ZV

heating zones valve with threaded connection

Art. No.	€ / U.	P (Unit)
BTZ ZV	64.27	5

Note:

During installation, it is important to observe the flow direction shown with an arrow on the valve.

Blank set

Schlüter®-BEKOTEC-THERM-PW

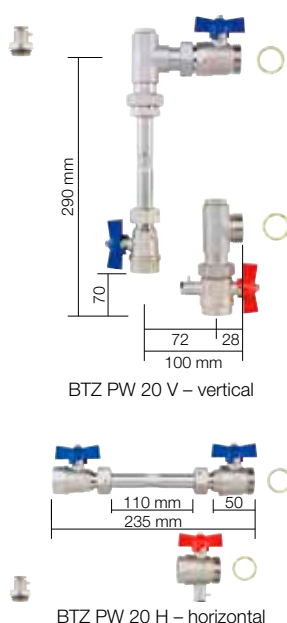

Schlüter-BEKOTEC-THERM-PW is a blank set for retrofitting a calorimeter.

Set includes:

- 1 adapter for calorimeter, length 110 mm, with outside threading 3/4" (DN 20)
- 2 ball valves 3/4" (DN 20)
- 1 ball valve 3/4" (DN 20) with sensor connection for directly immersed sensors (5 mm, M10 x 1)
- Separate sensor connector 1/2" for directly immersed sensors (5 mm, M10 x 1)
- 2 flat gaskets 1" (DN 25)
- 2 90° angles (BTZ PW 20 V only)

Schlüter®-BEKOTEC-THERM-PW

blank set for calorimeter

Art. No.	€ / Set	P (Set)
BTZ PW 20 V	167.50	5
BTZ PW 20 H	119.91	5

Note:

The blank set for the measuring mechanism of the calorimeter is usually attached to the cold leg. Depending on the connection situation, it may become necessary to attach the distributor terminal for the cold leg above or below. Follow the manufacturer's instructions for the selected calorimeter. The space requirements must be taken into account for selecting the distributor cabinet (see tables on pages 46 + 47).

Twin connection

Schlüter®-BEKOTEC-THERM-DA



Schlüter-BEKOTEC-THERM-DA is a twin connector made of nickel plated brass that features a 3/4" (DN 20) cone joint nut on one side and two 3/4" (DN 20) cone connector threads on the other side for connecting the Schlüter heating pipes with diameters of 10, 12, 14 or 16 mm.

The twin connector allows for setting up a second heating circuit at a heating circuit distributor branch. In this case, the heating circuits must have approximately the same lengths and performance ratings.

Schlüter®-BEKOTEC-THERM-DA

twin connector

Art. No.	€ / Package	P (Package)
BTZ 2 DA	70.25	10

Package = 2 units

Note:

The connection to the BEKOTEC-THERM heating pipes requires a set of clamp connections BTZ 2 KV... as well as two angle clips.

Offset connection

Schlüter®-BEKOTEC-THERM-S35



Schlüter-BEKOTEC-THERM-S35 is an offset connector made of nickel plated brass that features a 3/4" (DN 20) cone joint nut on one side and a 3/4" (DN 20) cone connector thread on the other side for connecting the Schlüter heating pipes with diameters of 10, 12, 14 or 16 mm.

The offset connector can be used to cover offsets of up to 35 mm for connecting a Schlüter heating pipe to a Schlüter heating pipe circuit distributor.

Schlüter®-BEKOTEC-THERM-S35

offset connector

Art. No.	€ / U.	P (Unit)
BTZ S35	41.60	10

Note:

The connection to the BEKOTEC-THERM heating pipes requires additional clamp connections BTZ 2 KV... as well as angle clips.

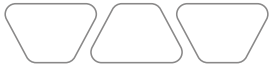

Return temperature limiter

Schlüter®-BEKOTEC-THERM-RTB



Schlüter-BEKOTEC-THERM-RTB is a return temperature limiter for concealed installation into the wall. The fitting is installed at the end of a BEKOTEC-THERM heating circuit. It serves to control the water temperature in upstream heating circuits and adjusts the floor temperature in rooms with existing heaters.

Set includes:

- Recessed wall installation box with adjustable installation depth
W x H x D = 145 x 145 x 57 – approx. 75 mm
- Plastic panel (brilliant white), 155 x 155 mm
- Two attachment brackets
- RTB valve made of brass, including evacuation and flush valve with valve connections AG 3/4" (DN 20)
- Stepless thermostat head for return temperature, adjustable from 20 to 40 °C
- Installation manual

Schlüter®-BEKOTEC-THERM-RTB

return temperature limiter valve

Art. No.	€ / Set	P (Set)
BT RTB V2W	237.86	5

Schlüter®-BEKOTEC-THERM-RTBR



Schlüter-BEKOTEC-THERM-RTBR is a combined room temperature control valve and return temperature limiter for on-wall mounting in connection with BEKOTEC-THERM radiant panel heating systems. The fitting is installed at the end of a BEKOTEC-THERM heating circuit. It limits the water temperature in the heating circuit and also regulates the room temperature.

Set includes:

- Recessed wall installation box with adjustable installation depth
W x H x D = 145 x 190 x 57 – approx. 75 mm and two angled attachment brackets
- Plastic panel (brilliant white), 155 x 210 mm
- RTBR valve made of brass, including evacuation and flush valve, adjustment range 20 to 40 °C, with valve connections AG 3/4" (DN 20)
- Installation manual

Schlüter®-BEKOTEC-THERM-RTBR

room temperature control valve

Art. No.	€ / Set	P (Set)
BT RTBR V2/W	306.72	5

Note

The following applies to RTB and RTBR:

The connection to the BEKOTEC-BTHR... heating pipes requires a set of clamp connections BTZ 2 KV... The connector fitting BTZ 2 AN... or the angled connector fitting BTZ 2 AW... can be used at the transition to the existing heating system (see page 41).

Prior to installation, a qualified expert should inspect the control technology and hydronic installations. The installation and assembly instructions of the manufacturer must be observed.

Maximum heating circuit lengths:

Heating pipe Ø 16 mm = 80 m

Heating pipe Ø 14 mm = 70 m

Heating pipe Ø 12 mm = 60 m

Heating pipe Ø 10 mm = 50 m

Schlüter®-BEKOTEC-THERM-RTBES

Return temperature limiter in a set with electronic thermostat

The Schlüter-BEKOTEC-THERM-RTBES set includes everything you need for efficient room temperature control.

The thermo-electric actuator is installed in the wall connection box with a removable, closed cover. The thermostat with 2" touch display regulates the room or floor temperature and enables timed control.

Set content

- ✓ Connection box with temperature control valve and return temperature limiter
- ✓ Cover, white plastic, closed
- ✓ Actuator 230 V (BT ESA 230 V2)
- ✓ Electronic thermostat, 2" touch display (DH E RT 2 / BW), see PS 25 for technical details



Schlüter®-BEKOTEC-THERM-RTBES

return temperature limiter with electronic thermostat

Art. No.	€ / Set	P (Set)
BT RTBE S1	490.75	5



Additional system components

featured in the Illustrated Price List PS “Profiles and Systems”



Schlüter®-DITRA



Schlüter®-DITRA-DRAIN



Schlüter®-DITRA-HEAT/-E

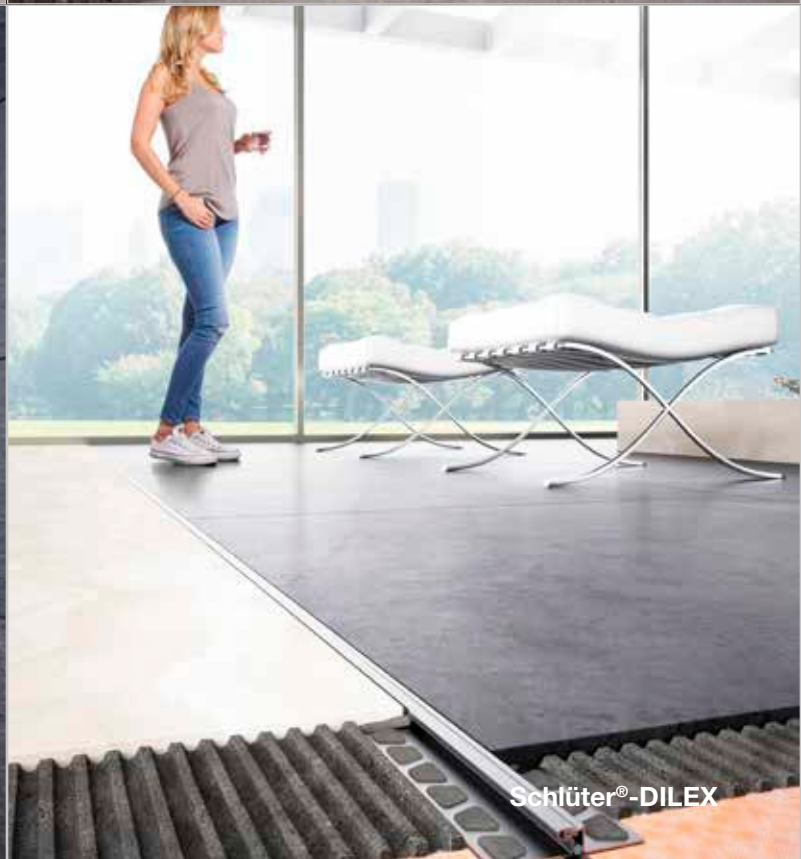

Schlüter®-DILEX

Waterproofing | uncoupling

Schlüter®-DITRA

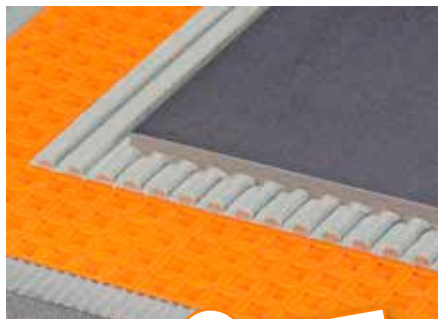

i

NEW: Schlüter-DITRA-PS with self-adhesive anchoring fleece can be found in the illustrated price list PS 25 on page 167.

Schlüter-DITRA is a polypropylene membrane with square, dovetailed Easyfill recesses and an anchoring fleece laminated to the underside. In conjunction with tiled coverings, Schlüter-DITRA forms an uncoupling, bonded waterproofing and vapour pressure equalisation layer.



Schlüter®-DITRA

polypropylene rolls

L x B = m ²	Art. No.	€ / m ²	PL (Roll)
5.1 x 0.995 = 5	D 5M	23.18	22
30.2 x 0.995 = 30	D 30M	19.21	6



Schlüter®-DITRA-DRAIN 4



Schlüter-DITRA-DRAIN 4 is an impact resistant polyethylene mat with a special stud structure on one side and a polypropylene webbing laminated on the upper side. It is a universal substrate for tile coverings, which serves as an uncoupling layer and a permanently effective passive capillary drainage mat.

Schlüter®-DITRA-DRAIN 4

polyethylene rolls

L (m)	width = 1.00 m Art. No.	€ / m ²	PL (Roll)
10	DITRA-DRAIN 10M	24.19	12
25	DITRA-DRAIN 25M	21.83	6



Schlüter®-DITRA-HEAT-E

Warm feet guaranteed



If you think an electrical floor and wall heating system is too expensive, re-calculate your investment with Schlüter-DITRA-HEAT-E. The system's quick heat-up response and precise control makes it easy to have warm feet without draining your wallet. The simple press-to-fit heating cables within the uncoupling membrane layer saves considerable time during installation.

- ✓ The pleasant room climate is suitable for allergy sufferers
- ✓ Precise customisable control
- ✓ Cost-effective, durable and maintenance-free
- ✓ Now even easier to cut and install
- ✓ Uncouples the covering from the substrate
- ✓ Also suitable for waterproofing

Waterproofing | uncoupling | heating



Schlüter®-DITRA-HEAT



Schlüter-DITRA-HEAT is a polypropylene membrane with a cut back stud structure and an anchoring fleece laminated on the underside. It is a universal substrate for tile coverings, which serves as an uncoupling layer, bonded waterproofing and vapour barrier, designed for the attachment of the matching heating cables for floor and wall heating solution.

i
The full DITRA-HEAT product line can be found in the illustrated price list PS 25 on page 168.

Schlüter®-DITRA-HEAT

polypropylene rolls

L x B = m ²	Art. No.	€ / m ²	PL (Roll)
12.76 x 0.98 = 12.5	DH5 12M	21.48	6

Schlüter®-DITRA-HEAT-MA

polypropylene mats

L x B = m ²	Art. No.	€ / m ²	PL (Unit)
0.8 x 0.98 = 0.78	DH5 MA	24.17	100

Heating cable

Additional
cables
in PS 25

Schlüter®-DITRA-HEAT-E-HK

12.5 W/m



Schlüter-DITRA-HEAT-E-HK is an electrical heating cable with a unilateral connection for installation in the uncoupling mat Schlüter-DITRA-HEAT. The cable has a heat output of 12.5 W/m.

Note:

Heating cables must not be shortened. When selecting the heating cable, please note that the table indicates the heated space in m², not the room size. To determine the heated space, deduct unheated zones such as perimeter areas and storage space from the room size.

Schlüter®-DITRA-HEAT-E-HK

heating cable

L (m)	Heated floor, 136 W/m ² *	Heated wall, 200 W/m ² **	Watts	Art. No.	€ / U.	P (Unit)
	m ²	m ²				
4	0.4	0.25	50	DH E HK 4	122.88	10
6.76	0.6	0.43	85	DH E HK 6	130.54	10
12.07	1.1	0.7	150	DH E HK 12	201.57	10
17.66	1.6	1	225	DH E HK 17	238.33	10
23.77	2.2	1.5	300	DH E HK 23	265.58	10
29.87	2.7	1.8	375	DH E HK 29	313.26	10
35.97	3.3	2.2	450	DH E HK 35	360.90	10
41.56	3.8	2.6	525	DH E HK 41	401.75	10
47.67	4.4	2.9	600	DH E HK 47	460.34	10
53.77	5	3.3	675	DH E HK 53	510.75	10
59.87	5.5	3.7	750	DH E HK 59	544.78	10
71.57	6.6	4.4	900	DH E HK 71	626.48	10
83.77	7.7	5.1	1050	DH E HK 83	735.45	10
95.47	8.8	5.9	1200	DH E HK 95	837.57	10
107.67	10	6.6	1350	DH E HK 107	919.31	10
136.16	12.7	8.4	1700	DH E HK 136	1101.95	10
164.07	15	10	2050	DH E HK 164	1318.10	10
192.27	17.7	11.8	2400	DH E HK 192	1542.18	10
216.27	20	13.2	2700	DH E HK 216	1733.32	10
244.37	22.7	15.1	3050	DH E HK 244	1944.21	10

* for use in floor and wall areas ** for use in wall areas only





Thermostat

Additional controllers in PS 25

Schlüter®-DITRA-HEAT-E-R6



Available colours:

BW **DA** BW = brilliant white
DA = dark anthracite

Schlüter-DITRA-HEAT-E-R6 is an all-in-one thermostat with WiFi connection and optional voice control. It controls floor and wall coverings that are electrically heated with Schlüter-DITRA-HEAT-E. As an alternative, the system can be operated via the 2" (5.1 cm) touchscreen display, with the Schlüter-HEAT-CONTROL app for iOS and Android or by voice control with Amazon Alexa or Google Assistant. The thermostat controls either the surface or room temperature based on a time schedule. An additional sensor, which is installed but left unconnected, is included within the box.

Schlüter®-DITRA-HEAT-E-R6

touchscreen thermostat (230 V) with two remote sensors, WiFi and Voice Control function

Art. No.	€ / Set	P (Set)
DH E RT 6 / BW	330.37	10
DH E RT 6 / DA	336.00	10

Note:

The remote sensor should be installed within the Schlüter-DITRA-HEAT uncoupling mat. Although two remote sensors are included, only one should be connected to the thermostat whilst the other is left unconnected as a spare.

Movement joint profile

Additional profiles in PS 25

Schlüter®-DILEX-KS



Schlüter-DILEX-KS is a movement profile with edge protection consisting of lateral anchoring legs made of aluminium or stainless steel, which are connected to a replaceable movement zone made of soft synthetic material.

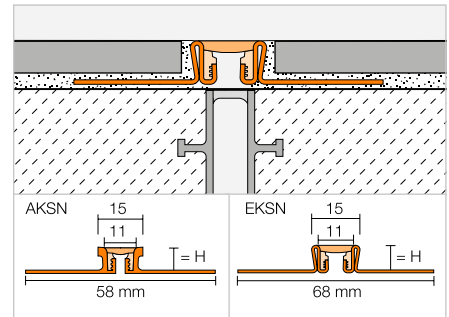

Schlüter®-DILEX-AKSN

aluminium

H (mm)	L = 2.50 m Art. No.	€ / m	KV (Unit)
8	AKSN 80 ...*	21.23	40
10	AKSN 100 ...*	21.91	40
11	AKSN 110 ...*	22.27	40
12.5	AKSN 125 ...*	22.65	40
14	AKSN 140 ...*	23.68	40
16	AKSN 160 ...*	25.39	40

Schlüter®-DILEX-EKSN

stainless steel V2A

H (mm)	L = 2.50 m Art. No.	€ / m	KV (Unit)
8	EKSN 80 ...*	42.96	40
10	EKSN 100 ...*	43.43	40
11	EKSN 110 ...*	43.87	40
12.5	EKSN 125 ...*	44.83	40
14	EKSN 140 ...*	45.60	40
16	EKSN 160 ...*	46.87	40
18.5	EKSN 185 ...*	48.04	40
21	EKSN 210 ...*	49.29	40
25	EKSN 250 ...*	51.65	40
30	EKSN 300 ...*	53.93	40

Schlüter®-DILEX-EKSN V4A

stainless steel V4A

H (mm)	L = 2.50 m Art. No.	€ / m	KV (Unit)
8	EKSN 80 ...* / V4A	47.23	40
10	EKSN 100 ...* / V4A	47.82	40
11	EKSN 110 ...* / V4A	48.40	40
12.5	EKSN 125 ...* / V4A	49.29	40
14	EKSN 140 ...* / V4A	50.16	40
16	EKSN 160 ...* / V4A	51.54	40

To complete the art. no., add the colour (e.g. EKSN 80 G / V4A)

C **DA** **FG** **G** **GS** **HB** **PG** **SG**

* Colours: C - DA - FG - G - GS - HB - PG - SG

Schlüter®-DILEX-F

The optimum supplement for BEKOTEC



- ✓ First movement joint profile that needs no embedding in the joint
- ✓ Consistently slim joint pattern
- ✓ Patented two-piece profile solution
- ✓ Continuous appearance of inserts (rolls)
- ✓ Platinum cured silicone insert with dirt-repellent technology
- ✓ Insert protected against stretching
- ✓ Joint profile with protective covering

Movement joint profile

Schlüter®-DILEX-FCS



Schlüter-DILEX-FCS is a movement carrier profile with lateral parts made of recycled rigid PVC that forms a slim movement joint of about 3.5 mm without edge protection that needs no embedding in the joint. The integrated protective covering is removed after tile installation to fit the insert Schlüter-DILEX-FIS. (Product data sheet 4.23)

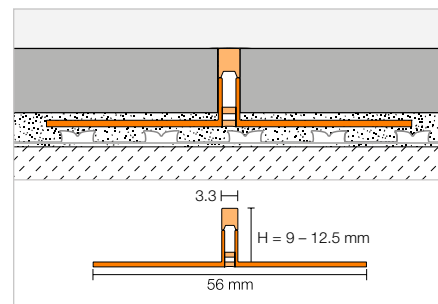

Schlüter®-DILEX-FCS

carrier profile PVC/CPE

H (mm)	L = 2.50 m Art. No.	€ / m	KV (Unit)
9	FCS 90	4.75	120
10	FCS 100	4.75	120
11	FCS 110	4.75	120
12.5	FCS 125	4.75	120

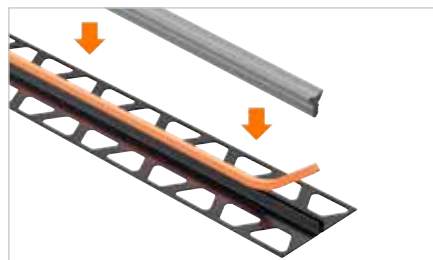

i
The matching inserts Schlüter-DILEX-FIS can be found in the illustrated price list PS 25 on page 129.



Calculation aids

The right quantities at a glance

Single-family home, 150 m²

BEKOTEC-THERM system		EN 23 FI 30*			EN-P			EN-PF		
Pipe installation spacing	mm	75	150	225	75	150	225	75	150	225
Heating pipe requirements	m/m ²	13.33	6.66	4.44	13.33	6.66	4.44	13.33	6.66	4.44
Costs for studded screed panels, heating pipes, edging strips (plus DITRA for ceramic tile coverings)	€/m ²	59.02	45.34	40.78	51.68	37.99	33.44	55.80	42.11	37.56
Additional costs for distributors, accessories, control units (lump sum)	€/m ²	29.72			29.72			29.72		
Estimated cost	€/m ²	88.74	75.06	70.50	81.39	67.71	63.15	85.51	71.83	67.27

* calculation based on heating pipes Ø 16 mm

Exhibit space / large commercial space, 500 m²

BEKOTEC-THERM system		EN 23 FI 30*			EN-P			EN-PF		
Pipe installation spacing	mm	150	225	300	150	225	300	150	225	300
Heating pipe requirements	m/m ²	6.66	4.44	3.33	6.66	4.44	3.33	6.66	4.44	3.33
Costs for studded screed panels, heating pipes, edging strips (plus DITRA for ceramic tile coverings)	€/m ²	58.24	44.56	40.00	35.17	30.61	28.33	39.28	34.73	32.45
Additional costs for distributors, accessories, control units (lump sum)	€/m ²	14.75			14.75			14.75		
Estimated cost	€/m ²	72.99	59.31	54.75	49.92	45.36	43.08	54.03	49.48	47.20

* calculation based on heating pipes Ø 16 mm

The cost of the Schlüter-BEKOTEC-THERM floor heating system depends on several project-specific factors. Calculation factors include the number and size of rooms, the number of heating circuits, the heating pipe spacing as well as the desired control technology. Based on our experience, we compiled the gross material costs for all required BEKOTEC-THERM components, including the necessary control technology for a typical single-family home, per square metre. As an alternative, we also calculated an average price per square metre for a large commercial space of 500 m². Prices do not include the cost of labour and are shown in the table. These values only represent calculated guidelines, which may differ for specific projects. Further installation components, such as insulation, Schlüter-DITRA, Schlüter-DITRA-HEAT or Schlüter-DITRA-DRAIN 4 and the covering need to be taken into account as well.



	EN 23 F			EN 23 F PS*			EN 18 FTS			EN 12 FK			EN 12 F PS		
	75	150	225	75	150	225	50	100	150	50	100	150	50	100	150
	13.33	6.66	4.44	13.33	6.66	4.44	20	10	6.66	20	10	6.66	20	10	6.66
	49.86	36.49	32.03	57.62	43.93	39.38	73.19	54.12	47.76	60.96	42.76	36.68	65.67	47.47	41.39
	29.72			29.72			29.72			29.72			29.72		
	79.58	66.20	61.75	87.34	73.65	69.10	102.91	83.84	77.47	90.67	72.47	66.39	95.38	77.19	71.11

	EN 23 F			EN 23 F PS*		
	150	225	300	150	225	300
	6.66	4.44	3.33	6.66	4.44	3.33
	33.66	29.21	26.98	54.79	41.11	36.55
	14.75			14.75		
	48.41	43.96	41.73	69.54	55.86	51.30

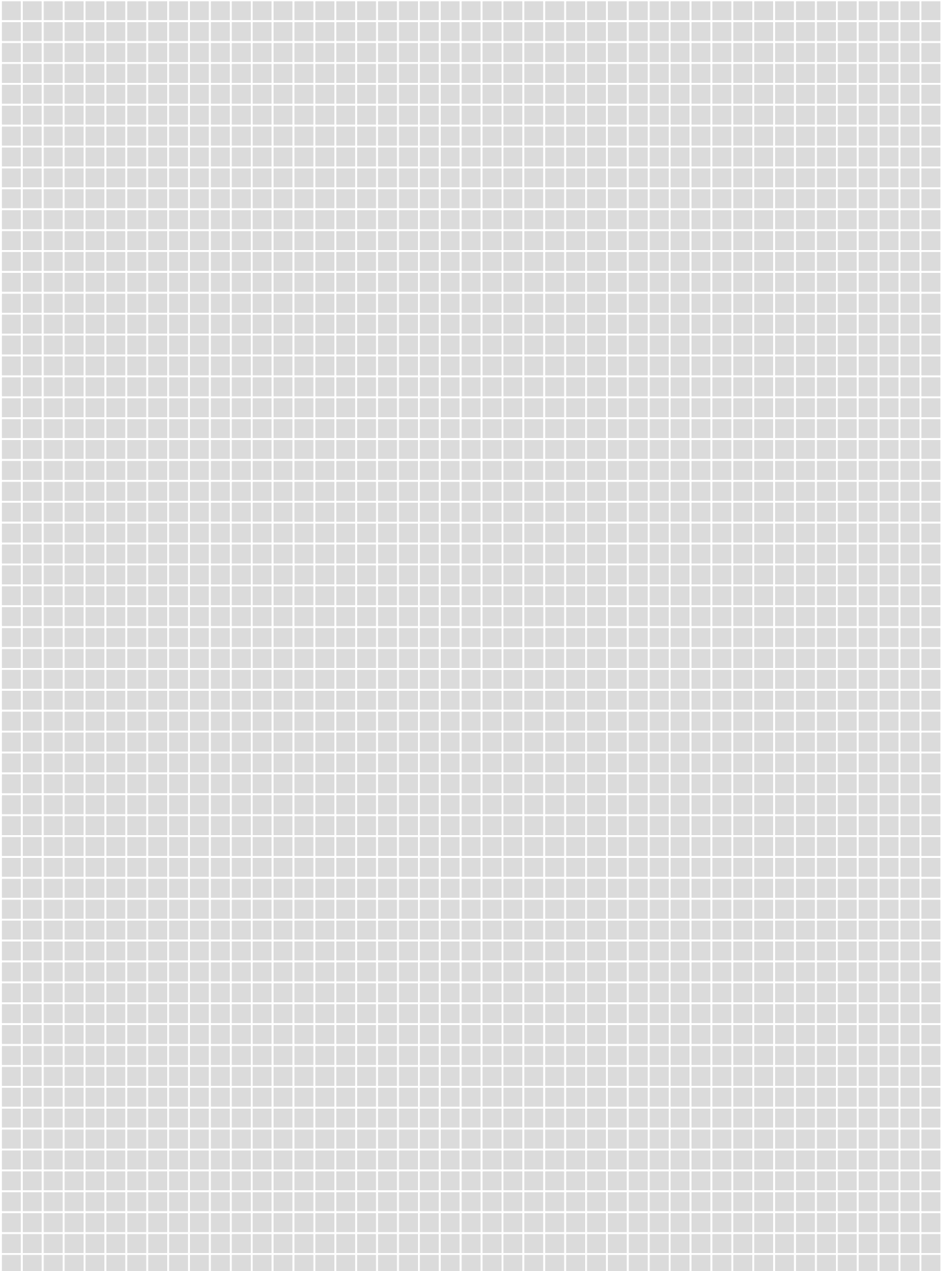

Experience Schlüter®-BEKOTEC-THERM

On our website

The website bekotec-therm.co.uk offers full information about the innovative floor heating assemblies of Schlüter-Systems. From informative videos to FAQs, the site offers all the information you need.

If you have additional questions, use the contact feature on our website to get in touch with us directly.

We look forward to hearing from you!

- ✓ **Everything you need to know about BEKOTEC-THERM**
- ✓ **Advice and services**
- ✓ **Videos**
- ✓ **Downloads**
- ✓ **Individual quotes upon request**
- ✓ **and much more!**



bekotec-therm.co.uk



Key

Innovations



New product

System functions



Heating



Cooling

Properties



Wireless control



Wired control



WiFi control



Voice Control function



Easycut gridlines



Easyfill design



Peel & Stick self-adhesive

Packaging units

PL = euro pallet

KV = case packaging

P = box packaging

Unit = units

Dimensions

H = height

L = length

B = width

T = depth

Technical developments may lead to changes from the images, drawings and descriptions.

General Terms and Conditions



Subject to the General Terms and Conditions of Schlüter-Systems Ltd.
All previous price lists lose their validity on the publication of this price list. Errors, changes, and printing mistakes as well as changes necessary in the interest of product innovation or shipping reserved.
For reasons of printing, colours shown in this price list may differ from actual product colours.

You can find the actual "General Terms and Conditions" of Schlüter-Systems Ltd. here:
<https://eu.schluter.com/en-GB/general-terms-and-conditions-2651.html>

The Bluetooth® word mark and logos are registered trademarks owned by Bluetooth SIG, Inc..
Other trademarks and trade names are those of their respective owners.

Subject to the General Terms and Conditions of Schlüter-Systems Ltd.
All previous price lists lose their validity on the publication of this price list.
Errors, changes, and printing mistakes as well as changes necessary in the interest of product innovation or shipping reserved. For reasons of printing, colours shown in this price list may differ from actual product colours.



Schlüter-Systems KG 📍 Schmölestraße 7 | D-58640 Iserlohn

☎ +49 2371 971-0 📠 +49 2371 971-1111 ✉ info@schlueter.de 🌐 schlueter-systems.com

Schlüter-Systems Ltd 📍 Units 3-6 Bardon 22 Industrial Estate | Bardon Hill | Coalville | Leicestershire | LE67 1TE

☎ +44 (0) 1530 813396 ✉ sales@schluter.co.uk 🌐 bekotec-therm.co.uk